

# IFB

## DeepClean®

POWERED BY 

### WASHING MACHINE USER MANUAL

DIVA SXN/GXN/MSN/MXN/MBN/SBN 6010K

SENORITA SXN/MSN/GXN/BXN 6512K

UF421PKMAN810 B

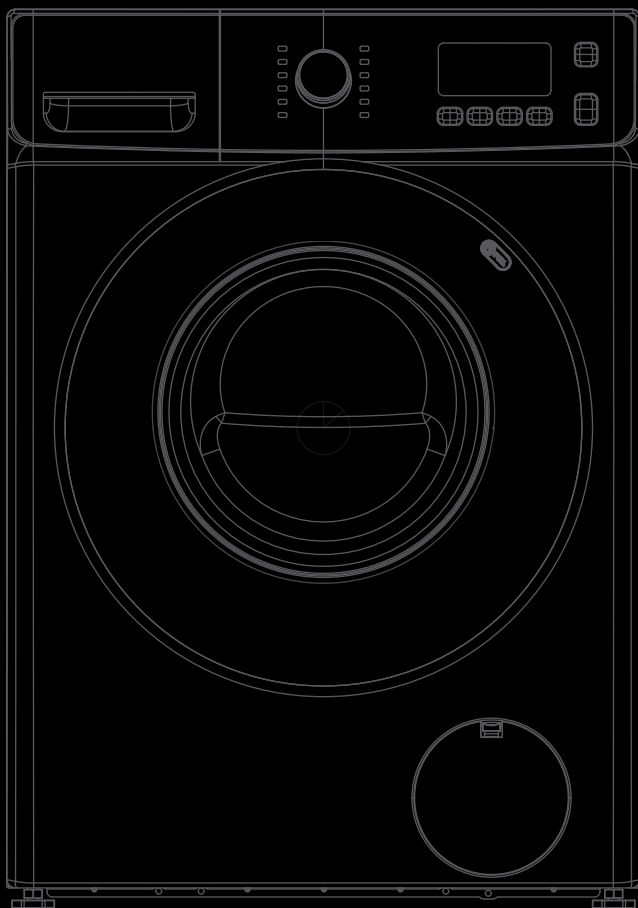

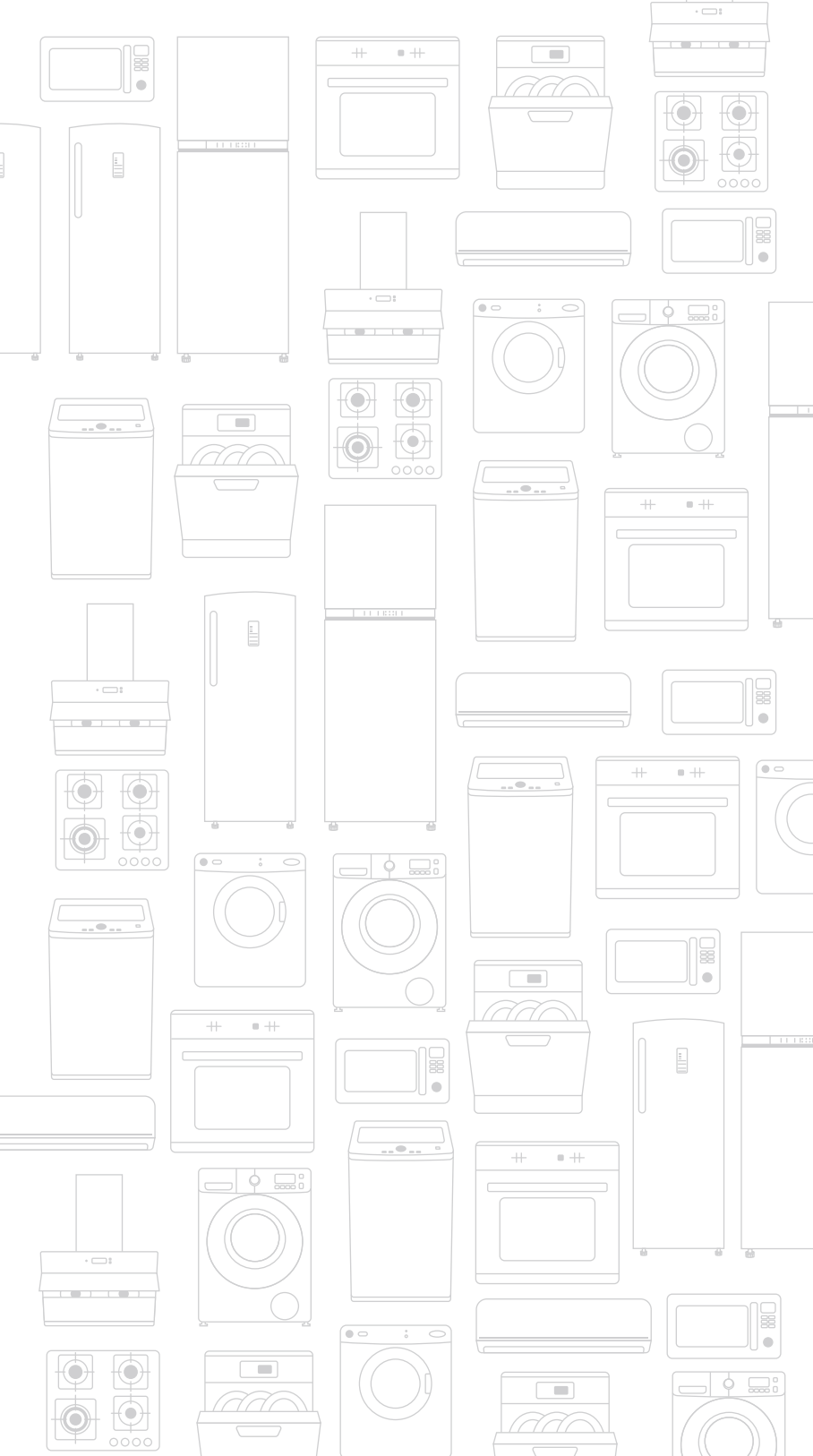

# Welcome to the IFB Family

Get ready to experience excellence  
in washing and long lasting peace  
of mind. Happy Laundry Days to you!

---

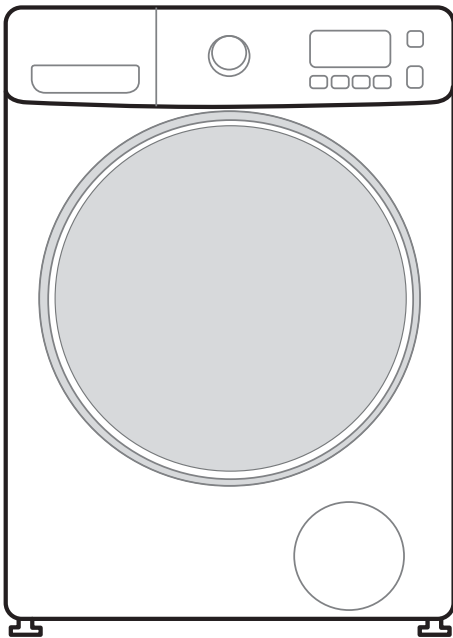

Front Load Washer

# Contents

<b>The A to Z of Your Washing Machine</b>	06
<b>The Display Panel</b>	08
<b>Safety Guidelines</b>	
Installation	11
Instructions	13
<b>Caution</b>	14
<b>About eWaste</b>	18
<b>Section 1 Getting Started With Your Washing Machine</b>	
Installation and Safety Guidelines	20
Before You Start	24
<b>Section 2 Running Your Machine</b>	
6 Easy Steps For Doing Your Laundry	25
Finishing	31
Program Guide	32
Wash Options	34
Wash Guide Map	41
Key Features	45
<b>Section 3 Getting More From Your Machine</b>	
Tips for Best Results	50
Stain Treatment	53
Maintenance and Cleaning	57
<b>Section 4 Useful Information</b>	
Troubleshooting	62
Display & Error Codes	71
Technical Specifications	75

## **PRECAUTIONS**

---

This appliance meets the required safety standards, but using it improperly could cause injury or property damage. Make sure to read this manual carefully—it covers safety, installation, use and maintenance. Use detergents with low foam to prevent any problems. Following these guidelines will help you get the most out of your new washing machine and keep it running smoothly while avoiding accidents or damage.

# The A to Z of Your Washing Machine



# The A to Z of Your Washing Machine

Power  
LED Display

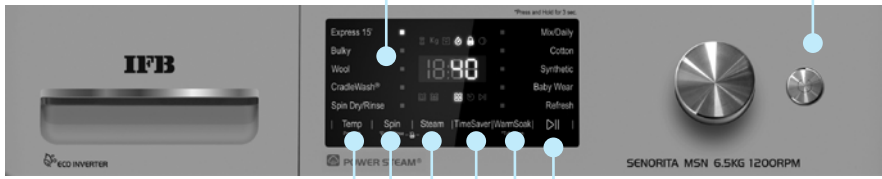

Temperature /Prewash  
Spin/Extra Rinse  
Steam  
Time Saver  
Warm Soak/  
Tub Clean  
Start/Pause

# The Display Panel

\*Press and Hold for 3 sec.



## 1 TEMPERATURE/PRE WASH

Touch this button to select/change wash Temperature. To select Pre wash option, touch this button till P-0C → P30C → P40C → P60C → P95C is seen on the display.

## 2 SPIN/EXTRA RINSE

To select/change Spin Speed use this button. Keep this button pressed for 3 secs to select the Extra Rinse option.

## 3 STEAM

Touch this button to Select/Deselect Steam function.

## 4 TIME SAVER

Touch this button to select Time Saver option.

## 5 WARM SOAK/TUB CLEAN

Touch this button to select the Warm Soak option. Keep the 'Warm Soak' button pressed for 3 secs to select the Tub Clean program. Once the Tub Clean program is selected, the message "tUb → Cln → 00:58 → tUb → Cln..." will be displayed on the panel.

# The Display Panel

\*Press and Hold for 3 sec.



 **POWER STEAM®**

## 6 **START/PAUSE**

Touch this button one time to Start/Pause the machine.

## 7 **TIME STATUS**

Displays Program Time, Spin Speed, Temperature, Error Codes and other status.

8  Time Left: Glows to indicate the time left.

 Glows to indicate the maximum capacity of the program in Kg.

 Laundry Add: Will flash till the Laundry Add function is available.

 Tap: Glows during water filling during wash process.

 Child Lock: Glows if option is selected.

 Door: Shows Door Status. Glows when door is open, flashes during door unlocking and remains OFF when door is locked.

# The Display Panel





\*Press and Hold for 3 sec.



 **POWER STEAM®**

## 9 OPTIONS

The corresponding options will—  
GLOW when selected,  
FLASH if available for selection and  
remain OFF if not selectable.

-  Glows if Pre wash option is selected.
-  Glows if Extra Rinse option is selected.
-  Glows if Steam option is selected.
-  Glows if Time Saver option is selected.
-  Glows during program run.



# Safety Guidelines

## FOR INSTALLATION

**Read all instructions & explanations carefully before installation. Choose the area where the machine will be placed carefully after reading the requirements.**



Keep the packaging material. It may come in handy when shifting residence.

Not removing all packaging and transit bolts before using your appliance could damage your appliance. Please do not operate your machine until the transit bolts have been removed.



Pre-installation plumbing and electrical connections must be handled by qualified fitters, electricians, or technicians.

All washing machine installation work must be carried out only by authorised IFB Care Service Personnel.

Use only the new hoses provided with the machine; old hoses should never be reused.

Do not connect your machine to a hot water supply.

This machine works best with water pressure between 0.3 and 10 bar (that's about 3.5 to 10 litres/ minute). If the water pressure is too low, your machine might malfunction.



Your machine comes with ventilating openings on the base. Always put it directly on the floor after removing any carpets.

Keep your machine safe from direct sunlight and rainfall.

Avoid installing the machine in damp areas or bathrooms exposed to direct showers

Don't put the machine on a sloping, uneven, or unstable surface.

Make sure your machine is installed in a room with adequate ventilation. Don't pick a room without windows. And make sure there's at least 4 inches (100 mm) of space between the back of the machine and the wall.

Don't put your washing machine in places where the temperature is below freezing. If hoses freeze, they could burst when under pressure. Also, the electronic control unit might not work if it's too cold (below freezing) or too hot (above 50 °C).

A concrete floor is recommended for installation, as it reduces vibration during the spin cycle compared to wooden floorboards.

Ensure the machine is placed on a stable, level surface to prevent vibrations during operation. All four washer feet should be levelled and balanced against the floor.

Before cleaning your machine, make sure you disconnect the main electricity supply & remove the plug from the socket.

Don't use your appliance near flammable stuff like oil, benzene, or highly flammable gas. These might start fires or explosions. And don't use combustible detergents that can catch fire either.



# Safety Guidelines

## INSTRUCTIONS FOR USE

**Safety first, always. Make sure you read all the instructions carefully before you start using the appliance. Keep the operating instructions handy for future reference**



Remember, if cockroaches or other pests cause any damage, the appliance guarantee won't cover it.

Don't install or use a machine that's damaged. Before you plug it in, check if the connection details on the data plate (like fusing, voltage and frequency) match your electricity supply. If you're not sure, reach out to IFB Care for help.

Avoid washing or drying articles contaminated with combustible or explosive substances, such as oil, paint, gasoline, or solvents, to prevent fire or explosions.

Before using the machine for the first time, ensure the transit bolt at the rear is removed (refer to the installation section).

If you're leaving the machine for a while, for example if you're going on holiday, remember to turn OFF the stopcock, especially if there's no floor drain nearby.

Keep children away from the appliance, and closely supervise them when the machine is in use.

Appliances are not intended for use by children. Parents or legal guardians are responsible for supervising or training children on safe product usage. Do not let children clean or maintain appliances without adult supervision.



## Caution

### A WORD OF WARNING



The manufacturer isn't responsible if there's a problem with the earthing system. Make sure your machine is connected to a grounded outlet with a 16A Fuse or MCB. If you're unsure whether the machine is properly grounded, get it checked by a qualified technician or licensed electrician.

If the earthing connection is not properly carried out, it could lead to electric shocks.

Make sure the machine is connected to a 3-pin socket with good earthing and 16 Amp MCB for protection against short circuits.

Avoid using extension cables with the appliance for safety reasons, as they do not meet the required levels of safety.

When disconnecting the plug, hold the plug itself, not the cord. Don't insert or remove the plug with damp hands.

Overheating could be a real danger.

Your machine has been built according to current safety requirements.

Your machine is totally disconnected from electricity when you switch it OFF at the wall socket and remove the plug, or turn it OFF from the main source, or remove the main fuse, or switch OFF the MCB.



## Caution



Letting unauthorised mechanics repair your machine, may pose unforeseen dangers. Only authorised IFB Care Service Personnel should undertake repairs.

Only use a new hose kit to connect your machine to the water supply on site. Don't try to reuse old hoses. If any parts need replacing, make sure to use genuine IFB spare parts. That way, you can be sure your machine meets safety standards.

Faulty connection cables must be replaced by authorised IFB Care Service Personnel to prevent potential danger to the user.

Never stack a washer and dryer without the proper stacking kit. This is dangerous because the dryer could shake off the washing machine while it is in use.

First use after installation—Condensed water droplets may remain inside the drum after assembly and test run. Run the first cycle without garments. Use the Cotton program at the highest temperature, add detergent, DO NOT put any clothes in the machine.

If the trolley vibrates excessively, it needs to be replaced right away. Otherwise, it could make the machine less reliable and shorten its lifespan.

If your machine has a porthole door, keep in mind that the glass might get hot when you're washing at high temperatures. Make sure children don't touch it.

Always ensure the drum is stationary before removing clothes to avoid accidents.

Avoid dragging the washing machine while its running to prevent damage.



## Caution

Keep your machine dry to avoid corrosion/rusting.

Don't spill water on the machine. If spills occur, wipe it dry. Your machine should be kept away from floor cleaning chemicals. Don't wash or spray water over the switch or control panel. Keep the machine dry to prevent corrosion and rusting. Make sure to wipe the machine after cleaning the coin trap.



Don't wash shoes or utensils in this appliance.

Check the labels on your clothes for the washing instructions for the fabric.

Use detergents that have been recommended for this washing machine.

Only use dyes specified by the manufacturer for domestic washing machines. Make sure to follow the manufacturer's instructions carefully.

Never use solvent-based cleaning agents in the machine. They can damage parts and produce dangerous fumes. Plus, they can also increase the risk of fire and explosions.

If your clothes have been treated with solvent-based cleaning agents before washing, make sure to rinse them really well in clean water before you put them in the machine.

Avoid using colour run and dye removers containing sulphur compounds, as they can cause corrosion or damage.



## Caution

Your machine has been built according to current safety requirements.

During assembly, the machine is tested with water to make sure it performs correctly. Sometimes, a few water droplets may be left inside the drum.

Replace the trolley immediately if excessive vibrations are observed, as it can affect the machine's reliability and lifespan.

### Flooding Danger

When you're connecting the drain hose to a washbasin, make sure the water drains away fast to stop the sink from overflowing. Also, make sure the hose is firmly in place so the water flow doesn't push it out. Otherwise, you might end up with flooding.

Be careful to not let things like nails, pins, coins, or paper clips end up in the machine with your laundry. They can damage parts like the suds container or drum, which can then ruin your clothes during the wash.

## USE OF APPLIANCE

**This appliance is intended to be used in household and similar applications such as—**

- Staff kitchen areas in shops, offices and other working environments,
- Farm houses,
- By clients in hotels, motels and other residential type environments,
- Bed and breakfast type environments, and
- Areas for communal use in blocks of flats or in launderettes.

If the manufacturer wants to limit the use of the appliance to less than the above, this shall be clearly stated in the instructions.

# About eWaste

eWaste, or Waste Electrical and Electronic Equipment (WEET), refers to discarded appliances using electricity. To responsibly manage eWaste, follow the guidelines below.



## **DOs**

---

- Always dispose of end-of-lifecycle products by contacting an authorised local eWaste recycler.
- Do drop off used electronic products, batteries, or accessories at authorised eWaste recyclers.
- Sort packaging materials for responsible waste disposal and recycling options whenever possible or as instructed.



## **DON'Ts**

---

- Do not dismantle electronic products on your own.
- Never dispose of electronic products in bins marked 'Do Not Dispose'.
- Refrain from giving eWaste to informal sectors like local scrap dealers or rag pickers.
- Do not dispose of your product in garbage bins along with municipal waste that ultimately reaches landfills.

## **RISKS OF IMPROPER HANDLING OF eWASTE**

eWaste usually includes components which, if disposed of improperly, hold environmental consequences such as air, water and soil pollution and also pose risks to human health.

By ensuring your appliance is disposed of correctly, you will help prevent potential negative consequences for the environment and human health. Components and materials used in this washing machine are fully compliant with the Provisions of Hazardous Substances outlined in eWaste Management Rule, 2016.



FOR DETAILED INFORMATION AND DISPOSAL REQUEST  
Contact **IFB Care** at **080 695 45678**. Provide your  
details to our representative to arrange for proper  
product disposal.

# Getting started with your washing machine

## Installation and Safety Guidelines

### 1 SELECTING THE RIGHT SPOT

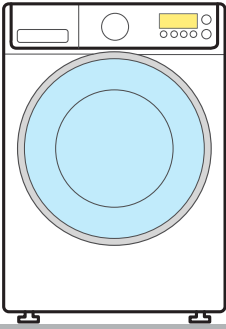

Place the machine on a level floor.

Make sure the machine is close to both water and electrical connections.



### 2 REMOVING TRANSIT BOLTS

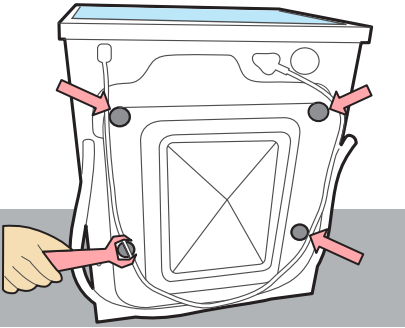

Use a spanner to remove the transit bolts.

Insert the plastic caps provided.

Keep the transit bolts carefully as they will be required in case you need to shift the machine.

Please do not operate the machine until the transit bolts have been removed.

# Getting started with your washing machine

## Installation and Safety Guidelines

### 3 LEVELLING

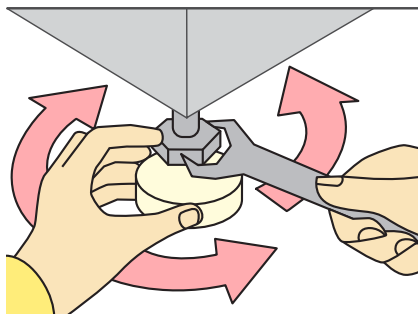

Level the machine by using adjustable screws, as shown.

Make sure all 4 feet are grounded.

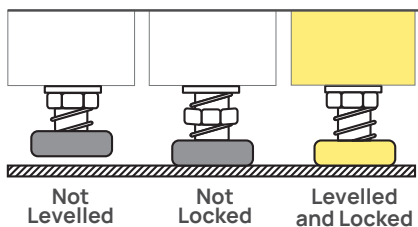
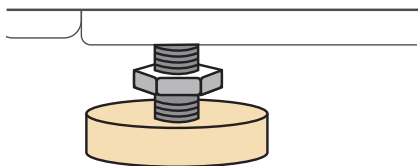
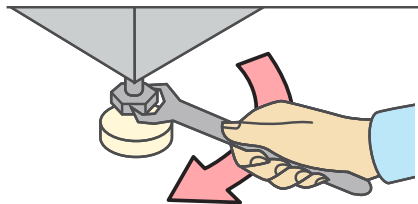

# Getting started with your washing machine

## Installation and Safety Guidelines

### 4 CONNECTION TO WATER SUPPLY

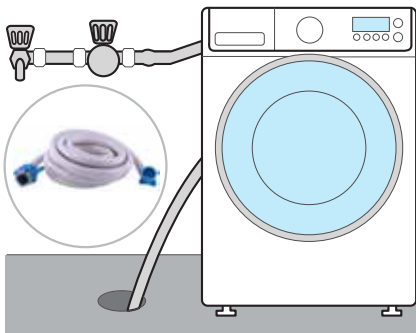

The water inlet of the machine has a collar with parallel internal threads.

Water supply point with a 3/4" external/parallel thread should be within 1 m of the machine.

Don't stretch the water supply hose.

**Note** After connecting inlet hose to water tap, turn on the water tap to flush out foreign substances such as dirt, sand or sawdust in the pipelines.

### 5 CONNECTION TO DRAIN HOSE

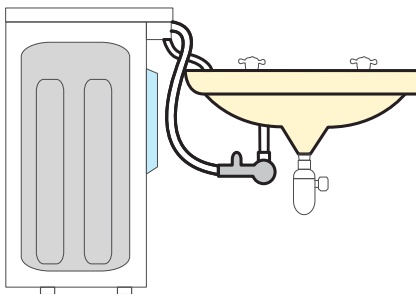

The machine uses a drain pump. Direct the end of the drain hose towards a sink.

The drain hose can be either placed on the floor or over a sink at a maximum height of 1 m from the floor.

# Getting Started With Your Washing Machine

## Installation and Safety Guidelines

### 5 CONNECTION TO DRAIN HOSE (contd)

Is the sink on the **left** side? Follow this diagram.

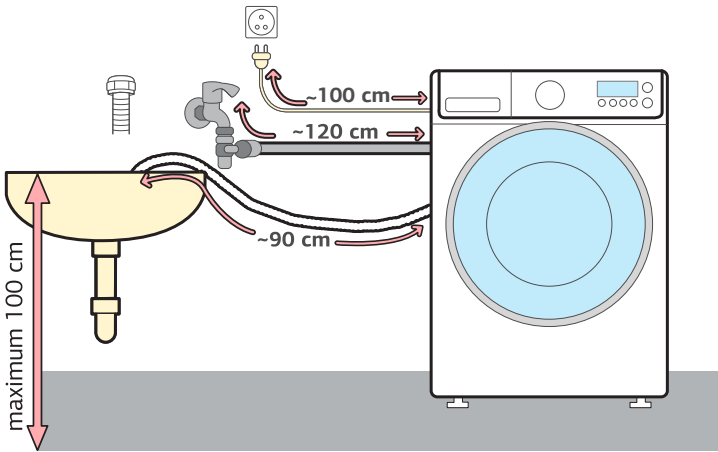

Is the sink on the **right** side? Follow this diagram.

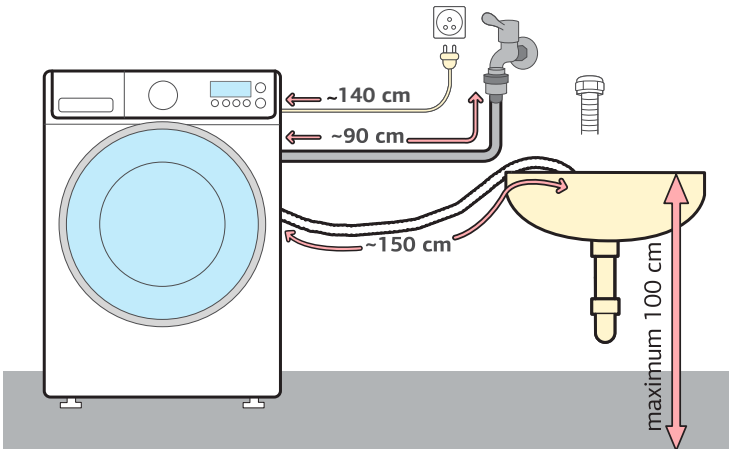

# Getting Started With Your Washing Machine

## Installation and Safety Guidelines

### 6 ELECTRICAL CONNECTION

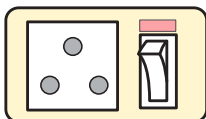
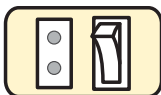
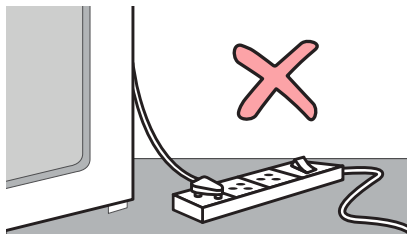

A 16 Amp, 3 pin 220-240 V AC, 50 Hz electrical point with a 16 Amp MCB within 1 m of the machine is mandatory.

Make sure your home has proper earthing and the connection between the socket and the plug is firm.

### BEFORE YOU START

**Make sure that the machine has been installed and connected as per the instructions above.**

To remove any water leftover from factory testing of your machine, the first wash cycle should be carried out without any laundry in the machine.

Turn ON the water tap,

- > Pull out the detergent drawer completely
- > Pour approximately 20 g of detergent in the dispenser
- > Close the drawer
- > Set the program selector knob to Cotton and maximum Temperature
- > Press Start/Pause
- > Switch OFF the machine when 'End' message is displayed.

# Running Your Machine

## 6 Easy Steps for Doing Your Laundry

1

### SORT THE LAUNDRY

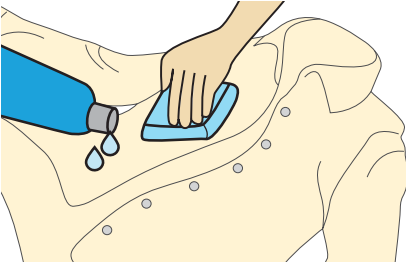

Pre treat collars, cuffs and stains.

Check for wash care symbols.

Close zippers, hooks and strings.

Empty the pockets of your clothes.



## 6 Easy Steps for Doing Your Laundry

### 2 LOAD THE LAUNDRY

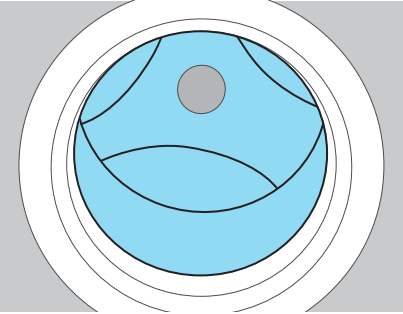

Make sure the laundry drum is empty.

Load garments one by one.

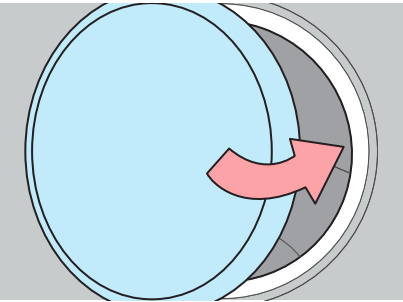

Close the door and press till you hear a click.

## 6 Easy Steps for Doing Your Laundry

## 3 ADD DETERGENT

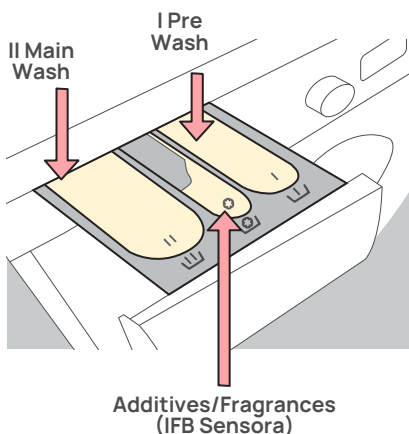

Pull out detergent dispenser drawer completely.

Add the correct amount of detergent.

- For heavily soiled clothes use Pre wash 'I' option.
  - For every other wash program use 'II'.
- ⊗ 'Settings' to be used to dispense additives. Use the fabric conditioner additives chamber and take care not to exceed the maximum level.

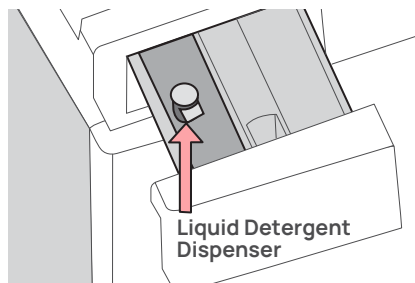

**Note** To be used to dispense Fragrances (Sensora) only during Refresh cycle.

If liquid detergent is used, use the liquid detergent dispenser supplied in the main wash chamber. Or close the flap in compartment 'II' and pour liquid detergent directly (model Specific)  
Note: Open the flap when using powder detergent.

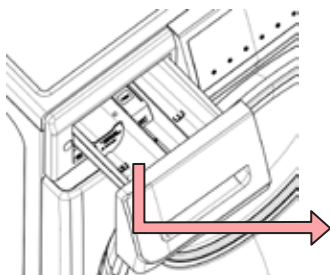

Flap Open - Powder Detergent  
Flap Closed - Liquid Detergent

## Running Your Machine

**Note**

Always use detergents that are recommended for front load washing machines. Using the wrong detergent can cause laundry issues. Avoid using soap flakes or granulated soap powders in your washing machine. When washing woollens or silk, make sure to use the detergent type recommended by the manufacturer. If you notice too many suds, reduce the amount of detergent you're using.

## 6 Easy Steps for Doing Your Laundry

## 4 SELECT PROGRAM

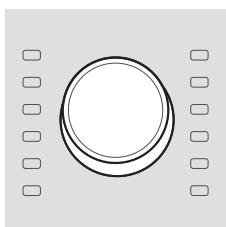

Switch ON the machine.

Turn the Program Selector knob to the required program.

Start/Pause LED will flash.

Choose Wash Option.



To change/cancel the program during the wash, press the Power ON/OFF button and wait for 2 secs, then select the new program.

For more information scroll to the **Program Guide** section.

## 5 SELECT WASH OPTIONS

Touch the option buttons to select desired Wash Option.

For more information scroll to the **Wash Options** section.

## 6 START WASHING



Press the flashing Start/Pause LED button to start washing.

To interrupt the cycle and change wash options or to add/remove laundry, press the Start/Pause button.

## 6 Easy Steps for Doing Your Laundry

## 6 START WASHING (contd)



Door status will be displayed after pressing the Start/Pause button.

If the water level inside the drum is above the rubber or the temperature inside the drum is high, the door won't open.

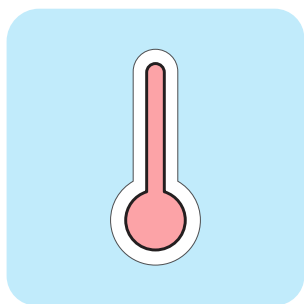

Once the wash is complete the 'END' message will appear. The door can be opened after this message.



The machine has been programmed to switch OFF all visual displays such as LEDs to save energy. Start/Pause LED will slowly blink after END of program. This is in line with the latest 'Energy Using Product' norms (EUP).

## Finishing

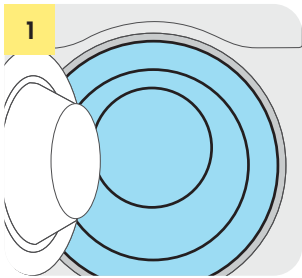

**1** Remove the laundry and wipe the moisture from the door and door seal. Leave the door slightly open.

**2** Wipe the panel and cabinet with a dry cloth to remove the moisture.

**3** Turn OFF the tap.

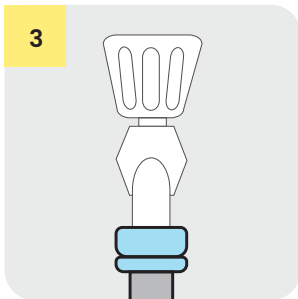
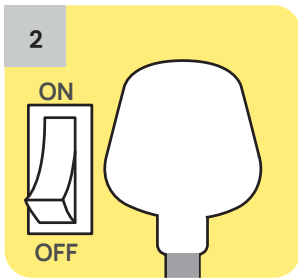

## Program Guide

PROGRAM	TYPE OF LAUNDRY
Mix/Daily	Cotton, synthetic and easy-care garments. Not recommended for special garments like silk/delicates, dark clothes, wool, duvets, curtains, etc.
Cotton	Cotton colour-fast garments. Shirts, pants, uniforms, bed and table linen, towels, night dresses, pyjamas, underwear, etc.
Baby Wear	High temperature and extra rinses for better rinse performance. Recommended for baby clothes, underwear, cloth diapers, pillows, bedsheets, etc.
Express 15'	Lightly soiled coloured laundry made of cotton, linen, synthetic or blended fabrics.
Refresh	For removing odour and de-wrinkling the laundry. Cotton, synthetic and mixed fabrics.
Wool	Machine washable woollen garments only. Use appropriate detergent.

## Program Guide

PROGRAM	TYPE OF LAUNDRY
<b>Synthetic</b>	Polyester, acrylic or polyamide daily wear garments.
<b>CradleWash®</b>	Hand wash and delicate wash garments. Silk, lingerie, satin, synthetic or sheer fabrics.
<b>Bulky/Bedding</b>	Machine washable cotton curtains. Large items like blankets, bedding covers, sofa covers, pillow covers and bedspreads.



# Running Your Machine

## Wash Options

### OPTIONS

### Details



Pre wash

#### Temperature/Pre wash

You can change the default temperature in the given range. Press the Temperature button on the control and select from Cold, 30°C, 40°C, 60°C, 95°C, P-0C, P 30°C, P 40°C, P 60°C, P 95°C, 40E, 60E Cold and Repeat.

(40E & 60E refer to Cotton Eco 40°C & Cotton Eco 60°C.)

**\*Note** For Cotton program, temperature selection sequence will be Cold, 30, 40, 60, 95, 40E, 60E, P-0C, P30C, P40C, P60C, P95, P0°C to P95°C - refers to Prewash option selection.

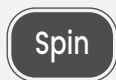

\*Extra Rinse

#### Spin Speed/Extra Rinse

You can change the default spin speed in the given range.

Press the Spin Speed button on the control panel and select from No Spin, 400 RPM, 600 RPM, 800 RPM, 1000 RPM, 1200 RPM, Rinse Hold and Repeat.

**\*Note** For 6010 models—Maximum Spin Speed selection is up to 1000 RPM. For 6512 models—Maximum Spin Speed 1200 RPM

## Wash Options

---

**OPTIONS****Details**

---

**Select****Extra Rinse**

An extra rinse cycle is executed to remove left over detergent from clothes.

Touch and hold Spin button on the control panel for 3 secs to select 1st Extra Rinse option. Next touch will select 2nd Extra Rinse. Next touch will select the 3rd Extra Rinse depending upon the program selected. Next touch will deselect the Extra Rinse option.

**Select****Steam**

When the Steam option is selected, steam is produced inside the drum—at the optimum wash time to enhance the wash.

Touch the Steam button on the control panel to select Steam or deselect Steam option.

Steam LED will glow indicating that the Option has been selected.

You can select more wash options or touch the Start/Pause button to start the program.

**\*Note** Steam option can be selected for Mix/Daily, Cotton, Baby Wear, Refresh and Rinse/Spin Dry programs.

It is normal that steam may not be visible during the Wash/Steam cycle.

Do not touch the door during the Steam cycle as the surface may be very hot.

Do not attempt to open the door forcibly or reach into the machine the Steam cycle. The steam can cause severe burns.

---

# Running Your Machine

## Wash Options

### OPTIONS

### Details



Select

#### Time Saver

This option allows you to save time by decreasing the programmed wash time.

Select the option in the control panel to select or deselect Timer Saver option.



Select

#### Warm Soak/Soak/Tub Clean

Soak clothes in hot, soapy water for a calculated amount of time to dislodge dirt during the main wash.

During soaking, the clothes will remain stationary for about 18 mins and then continue with the regular wash.

Touch the Soak button on control panel to select Soak/Warm soak option.

It is advisable not to soak coloured garments as they may bleed colour.



Options

#### Rinse Hold

If clothes are left unattended for a long time it may cause creasing.

This option pauses the program during its final rinse to prevent this.

'rinS HOlD' message will appear on the display.

You can cancel the current program or input your desired Speed/Spin and continue.

Press Spin Speed option till  $\text{E}=\text{=}$  is displayed.

## Wash Options

---

**OPTIONS****Details**

---

**Tub Clean**

Run this program to eliminate impurities, scaling, bacteria and unpleasant smell from the washing machine.

**IMPORTANT**

Do not put laundry in the washing machine during Tub Clean. Before running the Tub Clean program, empty the washing machine drum.

Do not use any Descale or any cleaning agents/additive with Tub Clean program.

To run the Tub Clean program—

Switch ON the washing machine.

The Tub Clean program can be selected by selecting Spin Dry/Rinse program → keep the Temperature button pressed for 3 secs.

Display Warm Soak Tub for 1 sec and cln for 1 sec indicating the Tub Clean program has been selected.

Touch the Start/Pause button to start the Tub Clean program.

END message will be displayed when the program is over.

---

## Wash Options

## OPTIONS

## Details

**Tub Clean Reminder**

The Tub Clean program reminder will appear on your washing machine after every 40 wash cycles. You can run the Tub Clean program or skip.

It is recommended to run the Tub Clean program after every 40 cycles to keep our washing machine clean

**\*Note** Tub Clean reminder will be displayed for 5 wash cycles and go OFF.

Spin



Steam

**Child Lock**

This activates protection against unintentional changes to the program sequence.

To select Child Lock, press the Spin and Steam buttons simultaneously for 2 secs.

No changes can be made while the program is running.

If the appliance is switched OFF, it will resume from where it was interrupted in this mode.

The door will remain locked till the end of the program.

You can disable this option the same way you enabled it.

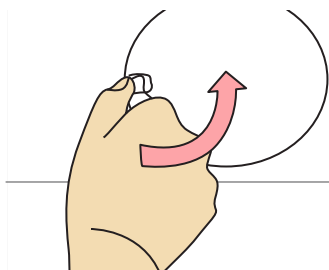
**EMERGENCY DOOR LOCK RELEASE**

**Note** Emergency door lock release should be used only during power OFF/power failure. Using this ends the current program.

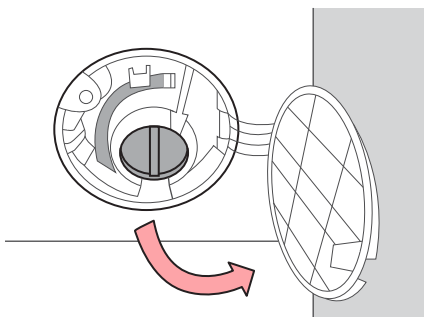
**PRECAUTIONS TO BE TAKEN FOR THE ABOVE**

Let the wash water cool down if it is hot.

Don't remove laundry from the drum while it is rotating.

Drain the water from the drum using the emergency drain pipe before releasing the door lock to avoid damage.

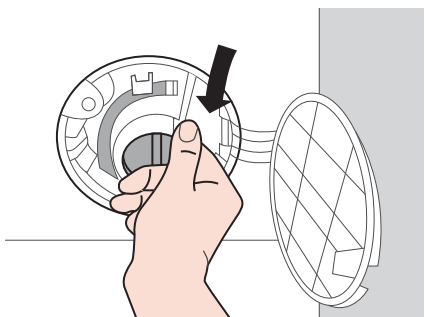
**EMERGENCY DOOR LOCK RELEASE DURING POWER FAILURE**

Program will continue after power supply resumes. If you still want to remove the laundry, switch OFF the power supply from the mains. Open the filter door, drain the water through the drain hose and then pull down the emergency lever to open the door.

# Running Your Machine

## Washing Symbols—A Guide



RESISTANT MATERIAL



DELICATE FABRIC



WASHABLE AT 95°C



WASHABLE AT 60°C



WASHABLE AT 40°C



WASHABLE AT 30°C



HAND WASH



DRY CLEAN ONLY



WOOL SEAL



BLEACHABLE IN COLD WATER



DON'T BLEACH



DON'T DRY CLEAN



DRY FLAT



HANG TO DRY



DRY ON CLOTHES HANGER



TUMBLE DRY, NORMAL HEAT



TUMBLE DRY, REDUCED HEAT



DON'T TUMBLE DRY

# Running Your Machine

## Wash Guide Map

	PRE WASH	WARM SOAK	EXTRA RINSE	STEAM	RINSE HOLD	TIME SAVER	LAUNDRY WEIGHT in KG	
							6010	6512

### PROGRAM

Mix Daily 60'	✓	✓	✓	✓	✓	✓	5	5
---------------	---	---	---	---	---	---	---	---

Temperature °C Cold, 30, 40, 60

Spin Speed RPM 400-1000/No Final Spin (6010)  
400-1200/No Final Spin (6512)

Cotton	✓	✓	✓	✓	✓	✓	6	6.5
--------	---	---	---	---	---	---	---	-----

Temperature °C Cold, 30, 40, 60, 95, 40E, 60E\*\*

Spin Speed RPM 400-1000/No Final Spin (6010)  
400-1200/No Final Spin (6512)

Synthetic	✓	✓	✓	✗	✓	✓	5	5
-----------	---	---	---	---	---	---	---	---

Temperature °C Cold, 30, 40, 60

Spin Speed RPM 400-1000/No Final Spin (6010)  
400-1200/No Final Spin (6512)

Baby Wear	✓	✓	✓	✓	✓	✓	3	3
-----------	---	---	---	---	---	---	---	---

Temperature °C Cold, 40, 60

Spin Speed RPM 400-800/No Final Spin

**Note** 40E, 60E programs—some options are not available | \*\* Program setting for BEE test in conformity with IEC 60456 with 1000 Spin Speed selection settings.

✓ Option available for selection

✗ Option not available for selection

# Default option cannot be deselected

✓\* Only available if Extra Rinse option is selected

# Running Your Machine

## Wash Guide Map

	PRE WASH	WARM SOAK	EXTRA RINSE	STEAM	RINSE HOLD	TIME SAVER	LAUNDRY WEIGHT in KG	
							6010	6512

### PROGRAM

Refresh	×	×	×	#	×	×	1 1-3 items	1 1-3 items
---------	---	---	---	---	---	---	-------------------	-------------------

Temperature °C × | Spin Speed RPM ×

Express 15'	×	×	✓	×	✓	×	2	2
-------------	---	---	---	---	---	---	---	---

Temperature °C Cold, 30, 40  
Spin Speed RPM 400-1000/No Final Spin (6010)  
400-1200/No Final Spin (6512)

Bulky Beddings	✓	✓	✓	×	✓	✓	2	2
----------------	---	---	---	---	---	---	---	---

Temperature °C Cold, 40, 60  
Spin Speed RPM 400-800/No Final Spin

Wool	×	×	✓	×	✓	×	2	2
------	---	---	---	---	---	---	---	---

Temperature °C Cold, 30, 40  
Spin Speed RPM 400-800/No Final Spin

**Note** 40E, 60E programs—some options are not available | \*\* Program setting for BEE test in conformity with IEC 60456 with 1000 Spin Speed selection settings.

- ✓ Option available for selection
- × Option not available for selection
- # Default option cannot be deselected
- ✓\* Only available if Extra Rinse option is selected

# Running Your Machine

## Wash Guide Map

	PRE WASH	WARM SOAK	EXTRA RINSE	STEAM	RINSE HOLD	TIME SAVER	LAUNDRY WEIGHT in KG	
							6010	6512

### PROGRAM

CradleWash®	✗	✗	✓	✗	✓	✗	2	2
-------------	---	---	---	---	---	---	---	---

Temperature °C Cold, 30, 40

Spin Speed RPM 400-600/No Final Spin (6010)

400-600/No Final Spin (6512)

Spin Dry Rinse	✗	✗	✓	✓	✓*	✓	6	6.5
----------------	---	---	---	---	----	---	---	-----

Temperature °C ✗

Spin Speed RPM 400-1000/No Final Spin (6010)

400-1200/No Final Spin (6512)

Tub Clean	✗	✗	✗	✗	✗	✗	✗	✗
-----------	---	---	---	---	---	---	---	---

Temperature °C Cold, 60, 95

Spin Speed RPM ✗

**Note** 40E, 60E programs—some options are not available | \*\* Program setting for BEE test in conformity with IEC 60456 with 1000 Spin Speed selection settings.

✓ Option available for selection

✗ Option not available for selection

# Default option cannot be deselected

✓\* Only available if Extra Rinse option is selected

## Running Your Machine

### Note

With Cotton Eco 60\*\* program, the actual wash temperature attained will be lower than 60°C, although the wash performance will be at par with the Cotton 60°C program.

The actual performance of the machine can vary based on a few factors like water pressure, water hardness, temperature, the amount and type of laundry, detergent used, and other conditions like foam or unbalance detection.

That's why the numbers mentioned in the user manual or with the machine might not always match with your experience, since they're tested in lab conditions.

Program time can also skip or extend due to above mentioned conditions.

Last run program is selected by default.

Machine automatically detects the weight of the laundry during the program and accordingly adjusts the Time/Rinse Water. Press and hold the Options button once during the program run to check the total number of wash cycles completed by the machine.

**The design and specifications (includes colour, shades, aesthetics, features etc) are subject to change without prior notice due to continuous improvement and product development.**

---

**Note** 40E, 60E programs—some options are not available | \*\* Program setting for BEE test in conformity with IEC 60456 with 1000 Spin Speed selection settings.

- ✓ Option available for selection    ✗ Option not available for selection    # Default option cannot be deselected    ✓\* Only available if Extra Rinse option is selected

## Key Features

## ADVANCED WASH TECHNOLOGY

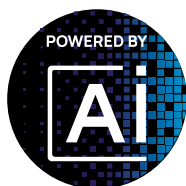
**Powered by Ai**

Available on selected models only

The intuitive sensing logic in the machine detects two parameters important for fabric care during cleaning—

- **Type of fabric** Cotton, Mixed or Synthetic
- **Weight of the fabric**

The Ai model, based on thousands of parameters, selects the optimised configuration suitable for the type of garment and its weight. Thus it helps in reducing the washing time and water consumption while ensuring the best care for your clothes without any manual intervention.

**Oxyjet® Technology**

Available in 10 Kg model

This technology is designed to blend energised water with detergent before it comes in contact with the clothes. The detergent solution is jet sprayed on clothes. At the same time, millions of oxygen bubbles are injected into the water solution that allows the detergent to penetrate deep inside the fabric to wash away the dirt and stains.

**9 Swirl**

Powered by Ai

Swirl technology that gently cares for your clothes.

## Key Features

---

### ADVANCED WASH TECHNOLOGY

---



#### 3D Wash

Jets of water and showers from the paddles completely soak the clothes. The water and detergent mixture is sprayed onto the clothes in a special mechanism for a better wash.

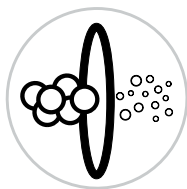

#### Aqua Energie

The technology that energises water to carry the detergent deep into the fabric.



#### CradleWash®

India's first wash program for the care of delicate fabrics.



#### Crescent Moon Drum

The crescent moon design of the drum allows the water to cushion the wash and protect the fabric.

---

## Key Features

---

### WASH PROGRAMS AND OPTIONS

---

More than 100 thoughtfully designed programs and options to give your clothes the ultimate wash experience.

---

#### Time, Energy, Water Saving

Cotton 40E/60E  
Express 15'  
Time Saver

---

#### Fabric Friendly Wash

Cotton, Synthetic,  
CradleWash®, Wool,  
Mix/Daily

---

#### Hygienic Wash

Baby Wear,  
Tub Clean

---

#### Customisable Modes

Spin Dry/Rinse,  
Express 15', Bulky  
Refresh

---

#### User Friendly Options

Pre Wash, Warm Soak, Temperature,  
Extra Rinse, Steam, Rinse Hold,  
Spin Speed

## Key Features

---

### MACHINE CARE

---

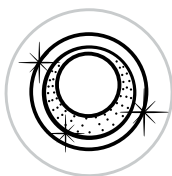

#### Auto Tub Clean

Automatically ensures tub hygiene after the wash.

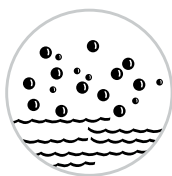

#### Auto Foam Control System

Auto detection and control of excess foaming.

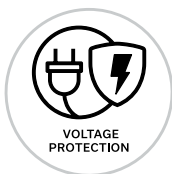

#### High-Low Voltage Protection

A microcontroller continuously monitors the voltage fluctuations and stops the program if it goes below  $150 \pm 10V$  or rises above  $270 \pm 10V$ . The program will resume once the voltage is within a safe range.



#### Program Memory Backup

The program remembers where to pick up from when power is restored after failure, thus saving on time, water, and energy, while adding longevity to the machine.



#### Auto Imbalance System

This system automatically balances the clothes inside to stabilise the spin cycle.

## Key Features

---

### USER CONVENIENCE

---



#### Child Lock

Prevents children from tampering with the machine settings.



#### Laundry Add

Lets you add laundry even after the cycle has started.



#### Anti Crease

Reduces wrinkling of clothes for easy ironing.

---

# Get More From Your Machine

## Tips for best results

### BEFORE WASHING



Empty all pockets. Remove everything including coins, keys, pins, notes etc.

Close all zips and fasten all hooks.

Check the wash care label and avoid non-machine washable items.



### WHILE SORTING



Separate polyester fabrics from cotton.

Try to have a mix of large and small clothes in each load.

Wash dark clothes separately.

## Get More From Your Machine

### Tips for best results

---

#### WHILE LOADING

---



Load large items first.  
Don't wash single items, add similar items.  
Place small items in a laundry bag.

---

#### WATER SOFTENING

---



Do you live in an area with hard water?  
You need to use water softening agents to get the best wash results.  
You may also adjust the detergent dosage to improve your wash.  
To do so follow the dose recommended by the detergent manufacturer.



# Get More From Your Machine

## Tips for best results

---

### EASY TIPS TO REMOVE STAINS

---

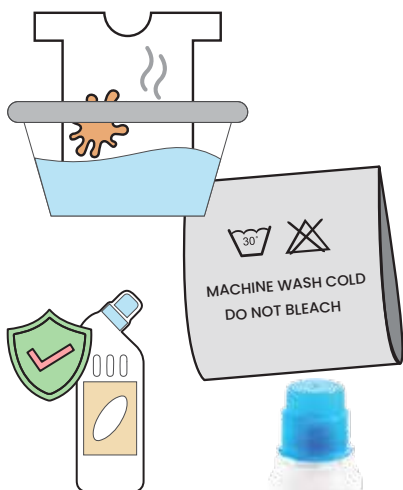

You can also use IFB Fabo Stain Remover for stubborn stains



Soak or pre wash the stained laundry in warm water.

Try to wash immediately after staining.

Understand the fabric, the nature of the stain and check the wash care label before treating it.

Start with cold or warm water as hot water can set the stain in.

Use fabric safe bleach if recommended.

Put the stained area face down on a paper towel or white cloth.

Apply the stain remover to the back of the stain so that the stain is forced out of the cloth.

SECTION

**3**

## Get More From Your Machine

Stain Treatment



## Stain Treatment

STAIN	TREATMENT
<b>Chewing gum</b> <b>Adhesive</b> <b>Tape</b> <b>Rubber</b> <b>Cement</b>	Use ice in a plastic bag to harden the gum. Scrape off what you can and then sponge with white spirits.
<b>Blood</b>	Rinse and soak immediately in cold water with an enzyme pre wash.
<b>Chocolate</b> <b>Cocoa</b>	Sponge with cold water and soak in enzyme pre wash.  Rub in a little detergent and rinse in cold water.
<b>Coffee</b>	Rinse in cold water. Rub in detergent and wash in the maximum temperature allowed for the fabric.
<b>Cream</b> <b>Milk</b> <b>Ice-cream</b>	Rinse in cold water and wash normally. Sponge with white spirits.
<b>Deodorant</b>	Rub affected area with white vinegar and then rinse in cold water.  Sponge with white spirits and then treat stiffened areas with an enzyme pre wash.
<b>Egg</b>	Soak in cold enzyme pre wash, rinse and wash.
<b>Fabric</b> <b>Softener</b>	Rub affected areas with bar soap and wash.

## Stain Treatment

STAIN	TREATMENT
<b>Fruit</b>	Treat as soon as possible by sponging with cold water. Rub a little detergent on the stain and wash.
<b>Grass</b>	Sponge with white spirits. Rub in an enzyme pre wash and then wash.
<b>Grease Oil</b>	Sponge with white spirits or dry-cleaning fluid and then wash.
<b>Iron Rust</b>	Apply lemon juice and salt and place in the sun before washing.
<b>Collars Cuffs Cosmetics</b>	Pre-treat with a pre wash stain remover or rub with a bar soap.
<b>Mildew</b>	Rub affected area with white vinegar and then rinse in cold water.  Sponge with white spirits and then treat stiffened areas with an enzyme pre wash.
<b>Mud</b>	Brush off the mud and rinse in cold water. Rub a little detergent and wash.
<b>Oil Paint</b>	Scrape off any fresh paint. Sponge with a non-flammable dry cleaning fluid and wash.

## Stain Treatment

STAIN	TREATMENT
<b>Water Based Paint</b>	Treat while still wet. Rinse in warm water and wash.
<b>Scorch Marks</b>	Dampen a cloth with hydrogen peroxide. Lay it over the affected area and press with a hot iron.
<b>Ink</b>	Some inks are impossible to remove. However, try using a pre wash stain remover, denatured alcohol or non-flammable dry cleaning fluid.
<b>Nail Polish</b>	Try applying nail polish remover to the back of the stain. Blot with paper towels and repeat. Don't use acetate fabrics. However, it may be impossible to remove in some cases.
<b>Shoe Polish</b>	<p><b>Liquid</b> Pre-treat with a paste of granular detergent and water.</p> <p><b>Paste</b> Scrape the residue and pre-treat with a pre wash stain remover or non-flammable dry cleaning liquid. Apply detergent to the dampened area and wash using bleach safe for the fabric.</p>
<b>Candle Wax Crayon</b>	Scrape off surface wax. Press with warm iron until wax is absorbed into a paper towel. Treat remaining stain with a pre-wash stain remover or non-flammable dry cleaning fluid. Hand wash to remove solvent and wash using bleach safe for the fabric.

# Get More From Your Machine

## Maintenance and Cleaning

### CLEANING THE DETERGENT DISPENSER DRAWER

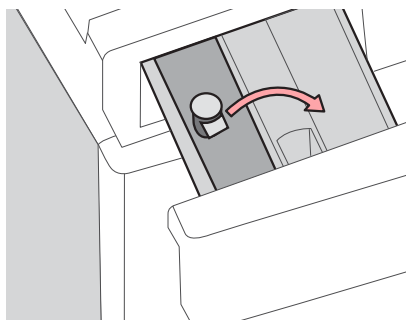

Remove detergent residue regularly.

Clean the detergent dispenser drawer with warm water.

Remove and clean the siphon under running warm water.

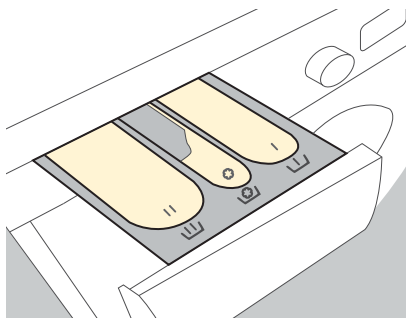

Detergent residue can build in the dispenser housing, clean it before reinstalling the dispenser.

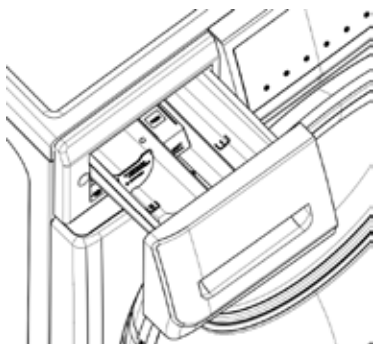

Or close the flap in compartment 'II' and pour liquid detergent directly (model Specific)  
Note: Open the flap when using powder detergent.

## Maintenance and Cleaning

---

### CLEANING THE WATER HOSE MESH FILTER

---

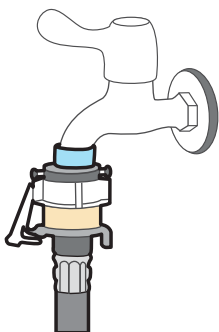

Turn OFF taps and disconnect the power supply to the machine.

Unscrew the inlet hose from the machine and tap the drain water from the hose.

Remove the filter mesh from the tap end of the inlet hose and clean under running water with a brush.

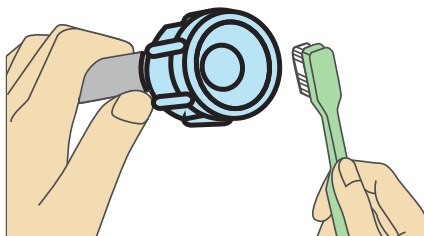

Pull out the sieve of the magnetic valve with a pair of flat nosed pliers.

Clean the sieve under running water with a brush.

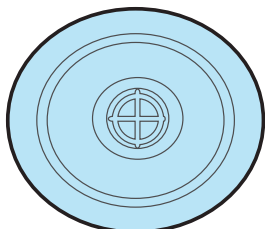

Fit the sieve back into the valve.

Screw the inlet hose back to the machine and the tap.

Turn ON the water tap to check if the connection is watertight.

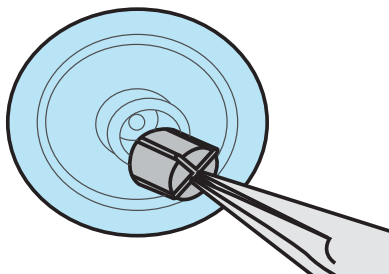

**Note** Dirt, sediments or sand in the water can affect both your wash quality and the water valve.

## Maintenance and Cleaning

### CLEANING THE FILTER

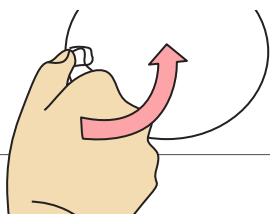

The filter should be cleaned frequently in order to increase the life of the drain pump.

Open the detachable bottom door with a coin or a key.

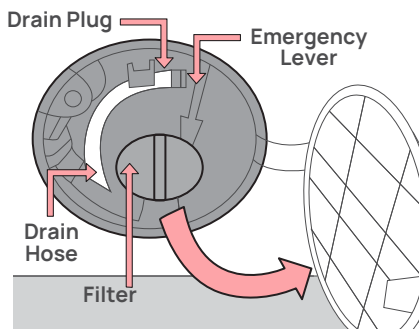

Place a shallow container near the bottom drawer.

Pull out the drain hose and open the drain plug.

Once the water is drained, turn the filter anti-clockwise to open it and take out any coins, pins, hooks, or other objects.

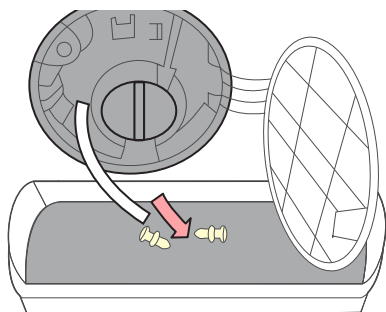

Tighten the filter and drain plug to their original positions, then close the bottom door.

Don't open the filter when a program is running.

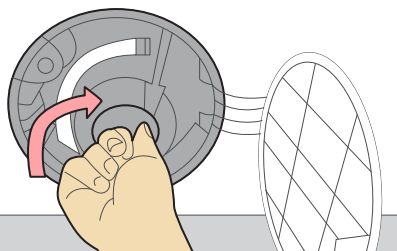

## Get More From Your Machine

Let's make washing easier.

Here is a list of clothes and their approximate weights to help you figure out a perfect wash load.

### CLOTHING WEIGHTS

#### Bottoms

Lungi/Dhoti	200 g
Skirts	200 g
Trousers	250 g
Jeans	400 g

#### Tops

Cotton Shirts	280 g
Other Shirts	200 g
Cotton Blouses	140 g
Other Blouses	100 g
Woollen Sweaters	400 g
Heavy Sweaters	300 g
Light Sweaters	150 g

#### Other Clothes

Cotton Sarees	650 g
Synthetic Sarees	350 g
Bath Towels	600 g
Hand Towels	250 g
Pyjama Kurta	400 g
Panties	60 g
Cotton Vests	100 g
Underslips	100 g
Long Socks, 2 pairs	150 g
Short Socks, 2 pairs	85 g
6 Handkerchiefs	85 g
12 Napkins	1.1 Kg

#### Sheets

Cotton (Double)	1 Kg
Cotton (Single)	500 g
Non Cotton (Double)	650 g
Non Cotton (Single)	400 g

#### Pillow slips

Cotton Pillow Slips	110 g
Other Pillow Slips	85 g

#### Table Cloths

Small	230 g
Large	600 g
Table Napkins (4)	150 g

#### Bedspread

3 Kg

#### Blankets

Wool	2 Kg
Acrylic	1.5 Kg

## Get More From Your Machine

This table may help you plan a laundry load of 6, or 6.5 Kg.

LAUNDRY ITEMS	6 Kg	6.5 Kg
Bath Towels	2	2
Shirts	3	4
Blouses	2	2
Skirts	2	3
Pair of Pants	1	1
Pair of Jeans	2	2
T-shirts	3	3
Set of Pyjamas	3	4
Tea Towels	2	2

The chart indicates average weights of clothes. Make sure not to overload your machine beyond the recommended weight. This way, your clothes will get a thorough wash. Suggested weights are approximate and may vary.

# Useful Information About Your Washing Machine

## Troubleshooting

In case of machine malfunction, check the following points before contacting your service provider.

SYMPTOM	PROBABLE CAUSE	SOLUTION
<b>LED Display is not lit.</b>	Power supply switch is not turned ON.	Turn ON the power supply switch.
	Electrical power cord is not plugged in or is loose.	Plug the electrical power cord in securely and check.
	No program is selected.	You need to select a program.
<b>Washing Machine Door is stuck and won't open.</b>	Machine is in operation.	Ensure that the program isn't active. If active, pause the program and check the door symbol on display. The door cannot be opened mid-operation, due to high water level, temperature and speed.
	Opening the door is not possible.	Check if the machine is displaying the 'dL Er' message.
	Child Lock is active.	Disable the Child Lock and wait until the Door display glows.

If the problem persists, contact IFB Care.

# Useful Information About Your Washing Machine

## Troubleshooting

SYMPTOM	PROBABLE CAUSE	SOLUTION
<b>Program does not start.</b>	Start/Pause button is not pressed ON.	Press the Start/Pause button. The display will glow to indicate activity.
	Water supply faucet is not turned ON; there is no or low water pressure.	Turn ON the water faucet fully. Ensure that the water pressure is normal.
	Machine door is not securely closed.	Close the machine door properly.
	Pause/Soak or Rinse Hold mode is active.	Check the status of the programs on display and refer to the user manual.
<b>Water is not supplied to the machine. Detergent is not flushed into the drum.</b>	Water supply faucet is not turned ON; there is no or low water pressure.	Turn ON the water faucet fully. Ensure that the water pressure is normal.
	Machine door is not securely closed.	Close the machine door properly.
	Inlet hose is bent, sieve, inlet valve or the hose is clogged.	Straighten the inlet hose. Check; unplug the sieve, valve and hose.

If the problem persists, contact IFB Care.

# Useful Information About Your Washing Machine

## Troubleshooting

SYMPTOM	PROBABLE CAUSE	SOLUTION
<b>Detergent dispenser is leaking suds.</b>	Unsuitable detergent is used.	Use detergents recommended for Front Load Washing Machines only.
<b>Excessive foam in drum.</b>	Excessive detergent is used.	Use less detergent.
<b>Detergent residue on clothes.</b>	Machine is overloaded with clothes.	Do not overload the machine. Put fewer clothes per load.
	Cold Wash program is active.	Choose the Hot Wash program.
	Water pressure is low.	Ensure that the water pressure is optimum.
<b>Water leakage in the machine.</b>	Inlet hose connection is loose.	Check and tighten the inlet hose connection.
	Filter is not securely tightened.	Check and tighten the filter.
	Inlet hose is leaking.	Contact IFB Care.

If the problem persists, contact IFB Care.

# Useful Information About Your Washing Machine

## Troubleshooting

SYMPTOM	PROBABLE CAUSE	SOLUTION
<b>Machine water is not draining.</b>	Filter is clogged.	Clean the filter. Make sure that it is not clogged.
	Drain hose end is placed 1 m above floor level.	Measure 1 m from the ground level, place the drain hose end below the level.
	Drain hose is kinked or clogged.	Ensure that the drain hose is straight, clean and unclogged.
<p>Wash only machine washable door/bath mats in the washing machine. Washing of non-washable mats will cause lint/fibre build up. This may lead to drain pump clogging.</p>		
<b>Machine vibrates excessively during spinning.</b>	Machine is not properly levelled.	Ensure that the machine is levelled properly.
	Filter is partially clogged.	Clean and ensure that the filter is unclogged.
	Load is unbalanced.	Add a few clothes to balance the load. Rearrange the load to allow proper spinning.

If the problem persists, contact IFB Care.

# Useful Information About Your Washing Machine

## Troubleshooting

<b>SYMPTOM</b>	<b>PROBABLE CAUSE</b>	<b>SOLUTION</b>
<b>Machine is not spinning or clothes remain wet.</b>	Load is too small, causing disbalance.	Add a few clothes to balance the load. Rearrange the load to allow proper spinning.
	Machine is overloaded with clothes.	Load clothes as per the fabric type and capacity recommended for the selected program. Reduce a few items.
	Spin Speed is set to 0 RPM or is too low.	Select a higher Spin Speed.
	Rinse Hold mode is active.	Select the Start/Pause button at Rinse Hold stage.
	Filter is clogged.	Clean and ensure that the filter is unclogged.
	Excessively foaming detergent is used.	Use detergents recommended for Front Load Washing Machines only.

If the problem persists, contact IFB Care.

# Useful Information About Your Washing Machine

## Troubleshooting

SYMPTOM	PROBABLE CAUSE	SOLUTION
<b>Ineffective treatment of soiled clothes.</b>	Detergent quantity is insufficient.	Use the recommended amount of detergent based on load size and hardness of water.
	Cold Wash program is active.	Opt for the Hot Wash program.
	Incorrect load size as per capacity.	Ensure that the load is within the capacity.
	Untreated stains on clothes.	Make sure to treat stains before washing. Scroll up to the 'Easy Tips to Remove Stains' section.
	Heavily and lightly soiled clothes are washed in the same load.	Wash heavily and lightly soiled clothes in separate washes.
<b>Blue stains on clothes.</b>	Excessive use of fabric additives.	Use only the required amount of fabric additives. Do not pour additives directly on the fabric.
	Additives of inferior quality being used.	Use good quality fabric additives.

If the problem persists, contact IFB Care.

# Useful Information About Your Washing Machine

## Troubleshooting

SYMPTOM	PROBABLE CAUSE	SOLUTION
<b>Black or grey stains on clothes.</b>	Detergent quantity insufficient as per hardness of water.	Use the recommended amount of detergent based on load size and hardness of water.
	Pre-existing stains on some clothes.	Separate stained clothes from the unsoiled ones.
<b>Yellow or brown, rust-like stains.</b>	The water supply for the wash is dirty.	Before washing—run the faucet to check if the water is clean. Wash only when the water is clean.  To restore a discoloured load of whites use a rust remover safe for fabric.
<b>Detergent residue left on clothes.</b>	Overloading of clothes.	Do not overload the washing machine.
	Excessive use of detergent.	Use proper amount of detergent.
	Cold wash program.	Use hot wash program.
<b>Buttons not working.</b>	Button not pressed properly.	All the buttons are sensitive and need to be pressed softly.

If the problem persists, contact IFB Care.

# Useful Information About Your Washing Machine

## Troubleshooting

---

### SYMPTOM

---

**Motor noise.** While in operation, it is normal for the motor to make some noise.

**Pump noise.** Unless the filter is clogged, it is normal for the pump to make some noise during the process of draining.  
Anyway do check for filter clogging.

**Program cycle time is delayed.** It is normal for the program cycle time to be delayed based on factors such as type and quantity of laundry load, inlet water pressure and temperature, fluctuation in power supply etc.

**Balance time on display remains unchanged.** In case of a disbalance in load, the machine makes attempts to redistribute the clothes to minimise vibrations. This can extend the duration of the program.

---

If the problem persists, contact IFB Care.

# Useful Information About Your Washing Machine

## Display

\*Press and Hold for 3 sec.



### THE LED DISPLAY GIVES YOU COMPLETE INFORMATION

- Program Selection
- Wash Option Selection
- Program Balance Time
- Program Status
- Problem/Fault Indications, if any
- Child Lock Selection
- Door Status

# Useful Information About Your Washing Machine

## Display Messages & Error Codes

For any code displayed that is not present in the following list or if the suggested solution does not fix the problem, contact IFB Care or an authorised dealer.

DISPLAY	PROBABLE CAUSE	SOLUTION
	<b>rinS HOLD</b> —Indicates that the machine is in the Rinse Hold mode.	Press Start/Pause button or select the drain program.
	<b>dLAY</b> —Indicates Delay Start.	
	<b>door</b> —Indicates that the door is not closed securely.	Close the door properly.
	<b>dLE</b> —Indicates that the washing machine door is stuck or jammed.	Switch OFF the washing machine and wait for 2 minutes before attempting to open the door again. Do not forcibly open the door. If the problem and/or the display persists, contact IFB Care



# Useful Information About Your Washing Machine

## Display Messages & Error Codes

DISPLAY	PROBABLE CAUSE	SOLUTION
tAP	tAP—Water supply tap is turned OFF.	Ensure that the Water supply tap is turned ON.
	tAP—Water supply is unavailable or water pressure is insufficient.	Operations will restart when water supply is available/normal.
	tAP—Sieve or filter in inlet hose is clogged.	Clean and unclog the sieve/filter. (Refer to 'Cleaning the water hose mesh filter' section).
	tAP—Water inlet hose is bent/damaged.	Remove and replace the bent/damaged water inlet hose.
E1 E2AndE3	E1 E2AndE3—Indicates that clothes are trapped between the door and drum area.	Switch OFF the washing machine and run the drain program. After the water drains out, rearrange the clothes and restart the wash program. If the problem and/or the display persists, contact IFB Care.



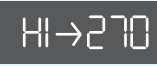

# Useful Information About Your Washing Machine

## Display Messages & Error Codes

DISPLAY	PROBABLE CAUSE	SOLUTION
	DP—Water not drained.	Touch Start/Pause button to restart the Drain program.
	Filter is blocked.	Switch OFF the appliance, drain out the water using the drain pump and then clean the filter.
	Exhaust hose clogged/bent.	Clean exhaust hose/remove bend.
	HOt—Water temp is above 60°C at the start of the program.	Start new/Drain program once the water cools down to approximately 60°C. Switch OFF the washing machine, wait for 2 secs and restart.
	HI→270—Input voltage is high.	Machine will start automatically after the voltage decreases to a safe operating level. If this error display persists/occurs frequently, contact your electrician to locate the fault in the electrical system.

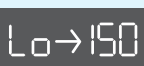
# Useful Information About Your Washing Machine

## Display Messages & Error Codes

DISPLAY	PROBABLE CAUSE	SOLUTION
	CO n	Switch OFF the appliance and wait for 2 seconds before restarting. If the problem and/or the display persists, contact IFB Care.
	Lo → 150—Input voltage is low	Machine will start automatically after the voltage increases to safe operating level. If this error display persists/occurs frequently, contact your electrician to locate the fault in the electrical system.
	U b L—Indicates that the laundry load is not balanced.	If the laundry load is small, it can cause disbalance in the drum and operations. Add a few clothes to balance and rearrange to allow proper functioning.
 		Switch OFF the washing machine, wait for 2 secs and restart. If the same message appears again, turn OFF the tap, switch OFF the appliance and contact IFB Care.

For further assistance please download My IFB App for service registrations or you call us on our call centre number

08045845678/ 080 695 45678

# Useful Information About Your Washing Machine

## Technical Specifications

<b>MODEL</b>	Diva SXN/GXN/MSN/MXN/MBN/SBN 6010K Senorita SXN/MSN/GXN/BXN 6512K
<b>POWER SUPPLY</b>	220-240 V Single Phase 50 Hz
<b>DIMENSIONS</b> cm Net Size WxDxH	598 x 518x 875
<b>NEW WEIGHT</b>	66 Kg
<b>CAPACITY</b>	6 Kg of Dry Cotton (6 Kg) 6.5 Kg of Dry Cotton (6.5 Kg)
<b>WASH CARE PROGRAMS</b>	10 (> 100 with options)
<b>SELECTOR BUTTONS</b> (Model Dependent)	Spin, Temperature, Steam, Time Saver, Warm Soak
<b>SELECTOR KNOB</b> (Model Dependent)	Program Selector Program Selector Knob
<b>SPIN SPEED</b>	400-1000 RPM or Spin Cancel (6 Kg) 400-1200 RPM or Spin Cancel (6.5 Kg)
<b>WATER CONSUMPTION</b>	≤ 9 Ltr/Kg/cycle ((Program setting for BEE test in conformity with IEC 60456)
<b>WATER PRESSURE</b>	0.3 Bar - 10 Bar (3.5-10 Ltr/min)
<b>RATING</b>	Refer to the product label
<b>DRAIN PUMP RATING</b>	30 W
<b>HEATER RATING</b>	2000 W
<b>DRUM</b>	Stainless Steel

TRUSTED BY OVER  
**10 MILLION**  
CUSTOMERS



+91 080 458 45678/080 695 45678

     +91 92310 04321

[www.ifbappliances.com](http://www.ifbappliances.com)