



IFB
Set yourself free

Refrigerator-Frost Free

USER MANUAL
Free Standing Appliance
Tru Convertible Series



01	SAFETY INFORMATION	2	05	SERVICE INFORMATION	5
	A) General safety information	2	06	SPECIAL FEATURES	5
	B) Safety of children and vulnerable persons	2	07	TEMPERATURE CONTROL SETTING	5
	C) Safety instructions to prevent risk of fire	2	08	TWIST ICE MAKER USAGE	6
02	IMPORTANT INFORMATION ON THE USE OF APPLIANCE	2	09	TROUBLE-SHOOTING GUIDE	6
	D) Food storage & food handling guidelines	2	10	CLEANING AND MAINTENANCE	6
	E) Advice for saving power with refrigeration appliances	3	11	HELPFUL HINTS	6
03	WARNING	3	12	DISPOSAL OF OLD APPLIANCE	7
04	INSTALLATION INFORMATION	3	13	WARRANTY & TERMS AND CONDITIONS	7
	F) Before using the appliance for the first time	3			
	G) Description of the Appliance	4			
	H) Installation of refrigerator	4			
	i. Guidelines for selecting refrigerator installation site	4			
	ii. Protect Flooring while installation	4			
	iii. Adjust the levelling feet	4			
	iv. Connecting Appliance to Power source	4			
	I) Instructions for relocating the refrigerator	4			

1. SAFETY INFORMATION

Please read the user manual thoroughly before operating the appliance and retain it safely for future reference.

A GENERAL SAFETY INFORMATION

- It is customer's responsibility to use the product with care and precautions as this manual does not cover all the possible situation that may arise.
- This appliance is intended solely for household purposes with the sole purpose of storing food and drinks at low temperature.
- Don't connect a fridge to the electricity supply until all packaging has been removed.
- Always ensure that the area you are placing the refrigerator is free of flammable materials such as EPS, gas cylinder and make sure that the ventilation openings provided in the appliance are clear of obstructions.
- Make sure you don't trap the mains cable beneath the fridge when putting it in position.
- After installation, the Plug of the refrigerator must be accessible to disconnect the appliance.

B SAFETY OF CHILDREN AND VULNERABLE PERSONS

- This appliance is not intended to use by children without supervision and adequate knowledge.
- This appliance can be used by children aged 8+ years and persons with reduced physical, sensory or mental capabilities or lack of experience and knowledge if they have been given instructions concerning use of the appliance in a safe way and understand the hazards involved.
- To avoid the risk of children becoming trapped and suffocating, do not allow them to play or hide inside the appliance.
- Cleaning and user maintenance shall not be made by children without supervision.
- ⚠️ WARNING: Improper use can cause physical damage and personal injury.

C SAFETY INSTRUCTIONS TO PREVENT RISK OF FIRE

- Plug the appliance into a grounding socket: the appliance must be correctly connected to an approved earthing system.
- Never use a loose power plug. It can cause an electric shock or catch fire due to an electrical short circuit.
- Do not use single/multi adapters or extension cords.
- In order to avoid a hazard, installation and maintenance, including Power cable replacement, must be carried out by a qualified technician, in compliance with the manufacturer's instructions and the local safety regulations in force. Do not repair or replace any part of the appliance unless specifically stated in the user manual.
- Do not use a heater or any sharp edge equipment to defrost ice build up inside the freezer.
- In case of gas leakage, ventilate the room instead of unplugging the refrigerator: Explosion or fire may occur.

- .case of emergency situations such as gas leakage, fire etc.
- Never block the interior or exterior ventilation openings of the refrigerator. Allow 100mm or more clearance over wall, side and rear plate of the refrigerator for air circulation
- Indoor refrigerators should not be stored outside as they are not designed for safe operation in an outdoor environment.
- Don't place a refrigerator near a heat source such as cookers, radiators, OTG Free-standing or in direct sunlight, as this will affect the cooling performance of the refrigerator.
- This manual covers various models and in case of any queries, please contact the nearest IFB service center.

⚠️ WARNING REGARDING THE REFRIGERANT ⚠️

- This appliance contains a small amount of isobutane refrigerant (R600a), which is flammable.
- In case of transportation or installation of the appliance, meticulous care is required to prevent any damage to the cooling system of the refrigerator. A gas leak is not hazardous to the environment, but it could cause eye injury or fire.
- In case of a gas leak, ventilate the room thoroughly, disconnect the appliance from the power mains and call a service technician.
- To prevent the creation of flammable gas- air mixture from the leak in the refrigerating circuit, the appliance should be in a room of more than 1m³ per 8g of R600a refrigerant inside the appliance. The amount of refrigerant is shown on the back side of the appliance.
- Never install the refrigerator at a humid place or the place where water splashes easily: Short circuit or fire may occur if you do it.
- If there is a burning smell from the refrigerator, unplug it immediately. It is very dangerous to leave the refrigerator running abnormally.
- Do not place heavy things on top or in close vicinity of the refrigerator ie. Liquid storage bins, burning candles, plastic/cloth refrigerator cover as it can cause fire due to short circuit.
- Do not plug or unplug the power cord with wet hands, as there is risk of electric shock.
- Unplug and clean the plug with dry cloth if found dirty: Dusty and dirty plug may cause fire.
- Clean behind your refrigerator regularly to keep lint and dust free.
- Never use any flammable aerosol spray or any flammable substances near the appliance.

2. IMPORTANT INFORMATION ON THE USE OF APPLIANCE

D FOOD STORAGE & FOOD HANDLING GUIDELINES

- Correct use of the appliance, appropriate packaging, maintaining the right temperature, and observing the food hygiene standards have a decisive impact on the quality of food storage.
- Observe the expiry dates for the food, indicated on the packaging.
- Do not store inflammable, volatile, and explosive substances in the refrigerator as it is not designed for chemical or scientific laboratory usage purposes.
- Bottles with high alcohol content should be tightly sealed and stored in an upright position.
- Food stored in the refrigerator should be kept in closed containers or in appropriate packaging to prevent it from emitting or receiving odors and humidity.
- Do not put large utensils on the shelf that may block the proper door closing which leads to energy loss.
- If you are leaving home for a longer period of time, remove perishables from the refrigerator.
- When purchasing deep-frozen food, comply with the following: Check the expiry date & Use the deep-frozen food before the expiry date.
- Danger of frostbite: Do not touch or put frozen food immediately in the mouth, as it may cause frostnip or frostbite.
- Do not store Glass bottles, cans or canned food in the freezer compartment: They can be broken or exploded due to thermal shock.
- During a malfunction of the refrigerator/freezer if food is stored too long inside, discard them, it can cause food poisoning.
- In case of an error or power supply failure, do not open the door frequently to avoid cooling loss. Please check with the local Electricity office to know how long the power shutdown lasts. If it is longer than 24 hours, please remove all frozen foods and decide accordingly.
- Unpleasant odor warns of lacking cleanliness of the appliance or perished contents.
- Frequent opening of the refrigerator/ freezer door or prolonging the cleaning time of the refrigerator/freezer may result in reduced storage life of food as these malpractices will alter the performance of the refrigerator.



2. IMPORTANT INFORMATION ON THE USE OF APPLIANCE

E ADVICE FOR POWER SAVING OF APPLIANCE

- Install the appliance as specified in the instruction manual.
- Keep the right temperature setting to avoid excessive running of the compressor.
- Do not place appliance in direct sunlight and avoid placement near direct heat source.
- Do not open the door more often than necessary.
- Do not keep the door open for a longer duration to avoid ice formation in the freezer.
- keep sufficient space around the appliance.
- Back of the appliance or wire Condenser unit should be kept clean.
- Ensure proper door closed with right gasket sealing
- Before placing the food in the refrigerator, allow it to cool down to room temperature.
- Thaw any frozen food in the refrigerator, thereby allowing to cool other foods with this low temperature.
- Avoid excessive stuffing inside refrigerator to Keep proper gaps for air circulation behind glass shelf
- This appliance intended to be used in household and similar applications such as
 1. Staff kitchen areas in shops, offices, and other working environments.
 2. Farm houses and by clients in hotels, motels and other residential type environments.
 3. Catering and similar non retail applications
 4. Bed and breakfast type environment.

3. WARNING

- Connect the appliance to the main power source, with the cord anchorage facing downwards.
- Do not plug or unplug the power cord with wet hands, as there is risk of electric shock.
- If the socket is loose in gripping the plug, fix the issue first and then secure the plug firmly.
- Hold the plug grip firmly and pull the plug out from the outlet.
- Do not use the power cord to place or hang objects, and do not bend the cord as it can cause physical damage to the power cord.
- After the installation, the appliance mains plug should be accessible.
- Do not use single/multi adapters or extension cords
- The appliance must be connected to the main power source and grounded in compliance with the electrical standards and regulations.
- Do not pour water on the refrigerator/freezer directly.
- Never use any flammable aerosol spray or any flammable substances near the appliance.
- Contact the IFB Service centre incase of excessive dust built up at the back of the refrigerator or if there are situations where excessive water enters the refrigerator.
- Plug the appliance into a grounding socket: the appliance must be correctly connected to an approved earthing system.
- Check if there is any leakage current by the professional electrician for safety reasons.
- Never use gas pipes, telephone lines or other potential lightning attractors as an electrical ground.
- This appliance is intended solely for household purposes with the sole purpose of storing food and drinks at low temperature.
- Do not store inflammable, volatile, and explosive substances in the refrigerator as it is not designed for chemical or scientific laboratory usage purposes.
- Use external door handle / built in Pocket handle to open and close the refrigerator, it is not recommended to open the door holding door sides or accessible gaps provided, you can hurt your hand while following malpractices.
- This appliance is not intended to use by children without supervision and adequate knowledge.
- This appliance can be used by children aged 8+ years and persons with reduced physical, sensory or mental capabilities or lack of experience and knowledge if they have been given instructions concerning use of the appliance in a safe way and understand the hazards involved.
- Keep the packaging material away from the children's reach as they can use the packaging as a play to cover themselves which could be fatal to life.
- To avoid the risk of children becoming trapped and suffocating, do not allow them to play or hide inside the appliance.
- Cleaning and user maintenance shall not be made by children without supervision.
- WARNING: Improper use can cause physical damage and personal injury.
- Do not use excessive pressure on door handles, or hang any load on the door like shopping bags etc, there is danger of refrigerator door misalignment or unbalanced product might fall off.
- Avoid placing the refrigerator to direct sunlight, near to heat source such as gas stove etc. as it can weaken the refrigerator cooling performance.
- Do not contact unauthorized service providers to carry out services for the appliance. The company will not hold any responsibility if there is any irreversible issue arising out of such malpractices.
- Do not try to replace the cord or attempt service on your own.
- Do not place heavy things on top or in close vicinity of the refrigerator ie. Liquid storage bins, burning candles, plastic/cloth refrigerator cover as it can cause fire due to short circuit.
- Do not reach out your hands or legs under the Refrigerator (when cleaning under the refrigerator), You will get hurt by rough edges and parts under the refrigerator.
- Prevent overloading the door bin, as there is risk of bottles titling off if they are not properly kept.
- Do not use a heater or hair drying to blow hot air or any sharp edge equipment to defrost ice buildup inside the freezer.
- Do not place any odor removal lighted gadgets inside the refrigerator.
- Place the shelf in the correct position until the shelf stopper position, if the shelf is placed upside down there will be cooling inefficiency /danger of shelf slipping off causing injury.
- Do not place bottles one above another in the bottle storage space, place them in the row, upright position secured in the shelf.
- In case of gas leakage, ventilate the room instead of unplugging the refrigerator: Explosion or fire may occur.
- Check for any damage or irregularities on your appliance. If you find your appliance is damaged, notify the retailer from which you have purchased the appliance.
- This appliance contains a certain amount of Isobutane refrigerant (R600a), a natural gas with not only high environmental compatibility but also combustibility.
- In case of transportation or installation of the appliance, meticulous care is required for no parts of the refrigerating circuit to be damaged. Refrigerant squirting out of the pipes could ignite or cause eye injury.
- If a leak is detected, avoid any naked flames or potential sources of ignition and ventilate the area for several minutes.
- Please tie the extra length of the power cord at the back of the refrigerator and make sure you don't trap the mains cable beneath the fridge when putting it in position.
- C-Pentane is used as an insulation blowing gas. The flammable insulation blowing gasses require a special disposal procedure. Do not try to separate any components from the refrigerator.
- For detailed information on product disposal, please contact the relevant municipal body in charge of waste management, your waste disposal service, or the store where you bought the product.
- Do not allow children to play with the appliance kept for disposal, supervise the children so that they don't harm themselves by locking themselves in the refrigerator.

4. INSTALLATION INFORMATION

F BEFORE USING THE APPLIANCE FOR THE FIRST TIME

- Before connecting the appliance to the main power source, please read carefully the instructions for use which describe the appliance and its correct and safe use.
- Check for any damage or irregularities on your appliance. If you find your appliance is damaged, notify the retailer from which you have purchased the appliance.
- Before connecting the appliance to the main power source, let the appliance rest in an upright position for a minimum 6 hours. This will reduce the possibility of operation faults because of transportation on the cooling system.
- The appliance will operate correctly if the environment temperature is in the interval specified in the table.
- Note: The cooling performance and power consumption of the refrigerator may be affected by the ambient temperature, the door opening frequency, and the location of the refrigerator. We recommend the temperature settings as appropriate.
- After the installation, the appliance mains plug should be accessible.
- Do not place the refrigerator near other appliances or devices which radiate heat, such as a cooker, a stove, a room heater, water heater etc., and do not expose it to direct sunlight. The appliance should stand at least 50 cm away from the heat source. If the distance between such source of heat and the appliance is smaller, use an insulating panel.
- Connect the appliance to the main power source using the power cord. The wall outlet should be fitted with a ground contact (safety socket). Nominal voltage and frequency are indicated on the rating plate/label with basic information on the appliance.
- The appliance must be connected to the main power source and grounded in compliance with the electrical standards and regulations.

CLASS	AMBIENT TEMPERATURE RANGE (°C) IEC 62552 (ISO 15502)
SN (Subnormal)	From +10°C to +32°C
N (Normal)	From +16°C to +32°C
ST (Subtropical)	From +16°C to +38°C
T (Tropical)	From +16°C to +43°C

Table - 1



4. INSTALLATION INFORMATION

G DESCRIPTION OF THE APPLIANCE

INTERIOR FEATURES OF FF 241L / 243L / 265L / 285L

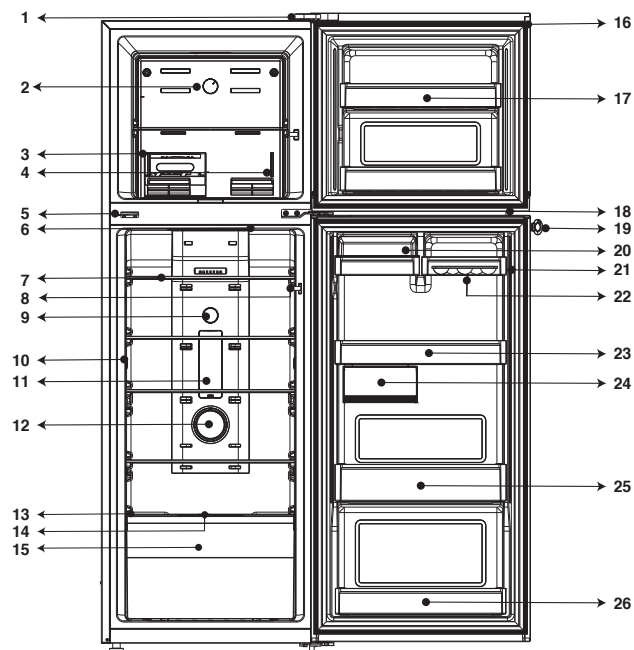

- | | |
|--|---------------------------|
| 1. DOOR HINGE COVER | 15. HEALTHY FRESH CRISPER |
| 2. FREEZER COMPARTMENT TEMPERATURE CONTROL KNOB | 16. GASKET |
| 3. TWIST ICE MAKER | 17. FROZEN FOOD BIN |
| 4. FREEZER COMPARTMENT PLENUM | 18. LOCK |
| 5. LOCK SUPPORT | 19. KEY |
| 6. REFRIGERATOR COMPARTMENT DIFFUSER | 20. DAIRY ZONE COVER |
| 7. TOUGHENED GLASS SHELF | 21. MULTI USE HALF BIN |
| 8. ROCKER SWITCH | 22. EGG TRAY |
| 9. REFRIGERATOR COMPARTMENT TEMPERATURE CONTROL KNOB | 23. SHALLOW FULL BIN |
| 10. SURROUND COOLING | 24. UTILITY BOX |
| 11. MULTIFLOW LED LIGHT COVER | 25. XL BOTTLE BIN |
| 12. ACTIVE DEODORIZER | 26. BOTTOM BIN |
| 13. HEALTHY FRESH CRISPER COVER | |
| 14. CRISPER COVER HUMIDITY SLIDER | |

This manual covers different models. The appliance purchased by you may have some or all of the above features.

H INSTALLATION OF REFRIGERATOR

STEP 1: GUIDELINES FOR SELECTING INSTALLATION SITE

- Install the appliance in a dry and well ventilated room.
- Solid and level floor**
 - Uneveled floor will cause vibration and noise while operating the refrigerator.
 - The Refrigerator should not be installed on the floor covered with carpet.
 - Adjust the refrigerator leveling legs as per the floor to prevent issues like door misalignment, refrigerator malfunctioning.
- Shady and humid place**
 - Avoid placing the refrigerator to direct sunlight, near to heat source such as gas stove etc. as it can weaken the refrigerator cooling performance.

- Avoid placing the refrigerator close to a sink and near a water source that can cause rust and corrosion.
- Avoid locations where moisture can cause electrical problems.
- Avoid placing the refrigerator just beneath the ceiling fan as it can cause frost formation inside the freezer.

The space required for installing the appliance is shown below. (unit: mm)

More than 100 mm from left, right, back sides and 250 mm from top is required for good ventilation. Insufficient space causes noise due to vibration, weakening of refrigerating cooling and waste of electricity.

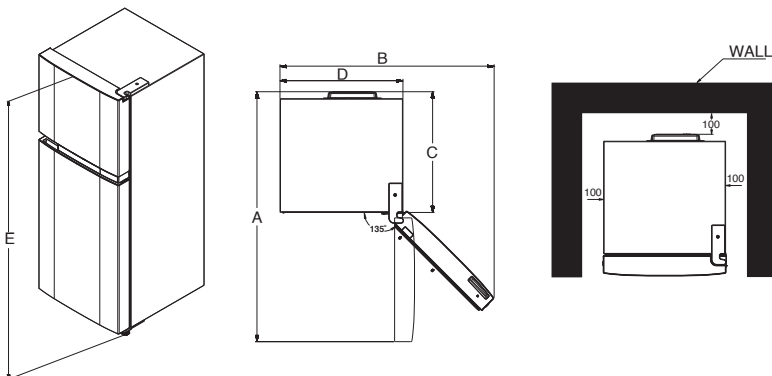

Refer Table 2 for dimensions

Model	A	B	C	D	E
FF 241L /243L	1200	1028	580	590	1544
FF 265L	1200	1028	580	590	1652
FF 285L	1200	1028	580	590	1738

Table-2

Caution: Please tie the extra length of the power cord at the back of the refrigerator and make sure you don't trap the mains cable beneath the fridge when putting it in position.

STEP 2: PROTECT FLOORING WHILE INSTALLATION

- The surface to install the refrigerator must be strong enough to support a fully loaded refrigerator.
- To protect the floor, put a large piece of cardboard on each leg of the refrigerator along the movement path of the Refrigerator
- Once the refrigerator is in its final position remove cardboard, do not move refrigerator unless necessary to protect the floor.

STEP 4: CONNECTING APPLIANCE TO POWER SOURCE

By completing the following steps, the refrigerator should be fully functioning.

- Plug the power cord into the wall socket to turn the refrigerator ON.
- Open the door to check the interior light is ON.
- Set the temperature at "Turbo cool" setting and wait for 1 hour.
- Wait until the refrigerator reaches the set temperature. Now the refrigerator is ready for use.

HOME INVERTER

Home inverter Specifications.

For Standard Compressor - 2000VA Capacity along with 120Ah Capacity battery.
For Inverter Compressor - 1500VA Capacity along with 120Ah Capacity battery.

I INSTRUCTIONS FOR RELOCATING THE REFRIGERATOR

- Empty the Refrigerator before relocating.
- Defrost the fridge, and wipe the refrigerator with a clean dry cloth.
- Unplug the refrigerator. Remove the power cord cable and secure it with a tie belt.

STEP 3: ADJUST THE LEVELING FEET

- There are two leveling legs under each front corner of the refrigerator.
- Turn leveling feet clockwise to raise the refrigerator and turn it anti-clockwise to lower it.
- Use shims under the rear corners if necessary

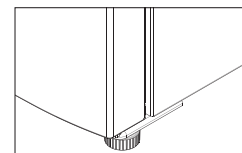

Notes:

1. Inverter should be in "ON" condition and battery shall be fully charged.
2. Ensure Refrigerator power supply socket is connected to the inverter supply.
3. While using home inverter, the refrigerator will work on basic cooling requirement.
4. Depending on the number of appliances connected to inverter, it may affect on the performance of the refrigerator.
5. For better performance of refrigerator, it is suggested to switch off other connected appliances.
6. It is suggested to check the quality of food before consumption.
7. Frozen food items may get soften like Ice cream, Green Peas etc when appliance is connected to home inverter, so it is gested to change the temperature setting accordingly.

- Protect the floor- refer to the instructions mentioned in installation of appliance: step 2 Floor protection instructions to be followed while moving the appliance.
- Reassemble and reconnect in the new house.



5. SERVICE INFORMATION

REPLACEMENT OF LED LAMP: In case of White LED light for refrigerator / freezer section failure which is not user serviceable part, contact an authorized IFB Service Centre which is near to your locality.

GASKET REMOVAL/DISCARDING METHOD:

- Gently hold one corner of the gasket and pull out the gasket from its grooves.

- To insert back, place the gasket along the groove first and then push it back in.

POWER CORD:

- Contact the service center to replace Power Cord if you find damage, heating up ETC.
- Do not try to replace the cord or attempt service on your own.

6. SPECIAL FEATURES

SURROUND COOL**

IFB's Surround Cool has 2 unique air vents on either sides in addition to the conventional rear vent thus delivering 360 degree surround cooling for better preservation

TRU CONVERTIBLE WITH 10-IN-1 MODES**

There are 10 cooling modes, namely -Normal, Turbo Freeze, Turbo Cool, Ice Cream, Power Saver, Mild Freeze, Marinade+, Dairy+, Beverage+ and Fridge+ that give customers a wide range of options based on their usage requirements.

MOISTURE BALANCED CRISPER

Honeycomb structure on crisper cover helps in maintaining moisture levels for fruits/vegetable freshness.

WHITE LED LIGHT

The Refrigerator compartment is illuminated by a bright white light that is visually pleasing to the eyes.

ANTIBACTERIAL GASKETS

Antibacterial gaskets help in preventing the growth of bacteria and mold.

**In select models only

7. TEMPERATURE CONTROLS

1. FREEZER COMPARTMENT TEMPERATURE CONTROL: (TRU CONVERTIBLE MODEL)

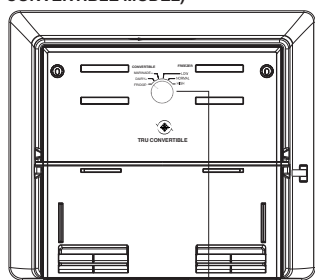

Freezer Air Flow Control Knob

The airflow control in the freezer, controls the distribution of cold air between the refrigerator compartment & freezer compartment, turn the knob to the left for lower cooling in freezer and to the right for fast ice setting. As per recommendation, it should be present in the Normal position for uniform cooling in freezer and refrigerator compartment.

1. FRIDGE+ TEMPERATURE SETTING
In this mode, you can convert your freezer into an extra fridge whenever you bring in additional groceries.

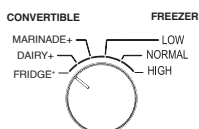

2. DAIRY+ TEMPERATURE SETTING
This mode offers you a 'Chiller-like' zone in the freezer, perfect for storing extra dairy items.

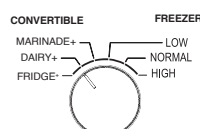

3. MARINADE+ TEMPERATURE SETTING
The freezer will be converted into Marinade+ mode. Ideal for use as a marination zone.

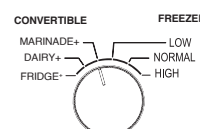

4. NORMAL TEMPERATURE SETTING
For even cooling needed in both the refrigerator and freezer compartment.

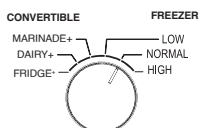

5. HIGH TEMPERATURE SETTING
For fast ice making or freezing in your freezer compartment.

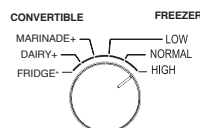

6. LOW TEMPERATURE SETTING
For normal ice in the freezer & when ice making is not a priority, activate Fast Cooling in your refrigerator compartment.

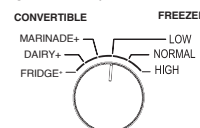

2. REFRIGERATOR COMPARTMENT TEMPERATURE CONTROL:

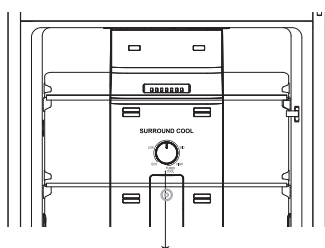

Refrigeration compartment temperature control knob

To control the temperature of refrigerator, turn the knob according to your requirement. This control is provided inside the refrigerator section. Turn knob to the left side to reduce the cooling and turn to the right to increase the cooling.

1. ECO TEMPERATURE SETTING

This mode saves power consumption and also called as Vacation Mode.



***Recommended not to use this mode in case of high usage condition or in Summer.

2. LOW TEMPERATURE SETTING

During winters or When quantity of foods stored in refrigerator are low or require less cooling.

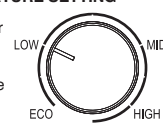

3. MID TEMPERATURE SETTING

During monsoon or when quantity of foods stored for normal usage.

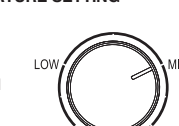

4. HIGH TEMPERATURE SETTING

During Spring & Summer or when there is a lot of food stored in the refrigerator.

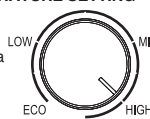

5. TURBO COOL SETTING

During peak summer or When requirement is faster/quick cooling of items for short period. Note: For long running of this mode can freeze the refrigerator compartment items.

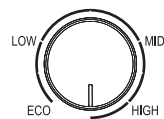

MODES FOR TRU CONVERTIBLE MODELS

MODES	Freezer Compartment Knob Position	Refrigerator Compartment Knob Position
*NORMAL (Default setting for normal use.)	FREEZER NORMAL	MID
**TURBO FREEZE (This mode can be used for fast Ice.)	FREEZER HIGH	HIGH
**TURBO COOL (This Mode can be used to cool the items faster in the Refrigerator compartment.)	FREEZER LOW	TURBO COOL
**ICE CREAM (Ideal Temperature to store Ice cream or frozen desserts)	FREEZER NORMAL	LOW
***POWER SAVER (This Mode can be utilized when the refrigerator is relatively empty. Also known as 'Vacation Mode', it offers enhanced energy savings.)	FREEZER NORMAL	ECO
***MILD FREEZE (This Mode is used to make Items softer and ready to consume from freezer compartment.)	FREEZER LOW	LOW
****MARINADE+ (This Mode offers you the soft zone compartment which can be used for marination.)	MARINADE+	LOW
****DAIRY+ (Convert the freezer to 'Chiller' mode for storage of extra dairy items.)	DAIRY+	LOW
****BEVERAGE+ (Convert the freezer to a Beverage Zone when you have extra beverages to store.)	FRIDGE+	BETWEEN LOW & MID
****FRIDGE+ (This Mode allows you to convert freezer to a fridge for extra storage.)	FRIDGE+	LOW

*Recommended for normal use.

**Recommended to use this mode for 12 Hour Max in case the Refrigerator compartment has load.

***Recommended not to use this mode in high usage conditions or in summer.

****For effective conversion from freezer to fridge mode or vice versa:

- Kindly make sure to remove frozen food from the freezer compartment before converting the freezer into Fridge.
- In Fridge+ mode, the freezer temperature is increased, leading to a rise in the temperature of frozen food items. Consequently, items may thaw or spoil.
- Ensure to remove food items from the refrigerator compartment before switching to freezer mode, as the low temperature may cause fridge food to freeze (Fridge Mode convert into Freezer Mode).
- Don't put glass bottles containing liquid in the freezer. The glass bottle may break or burst in the freezer.

This manual covers different models. The appliance purchased by you may have some or all of the above features.



8. TWIST ICE MAKER USAGE

TWIST ICE MAKER

Movable Twist Ice maker assembly is provided inside the Freezer Compartment of the Refrigerator.

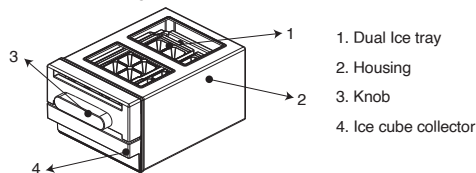

ICE MAKER

Gently slide & take out the Dual Ice tray assembly and place it on a level surface. Now fill the cubes of ice tray with water up to the level indicated as per the requirement. Slide it back to its original position inside the housing. Before taking out the ice from dual Ice tray, Ensure that the Ice cube collector is in its default position. Now gently twist the knob to right side to dispense Ice cubes on to the Ice collector box.

NOTE: Ice making time can vary based on your Freezer knob position, refrigerator temperature settings & ambient conditions.

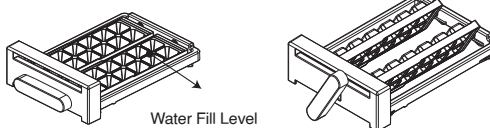

9. TROUBLE-SHOOTING GUIDE

Before calling for service, check for the following observations and their potential reasons and suggestions to try out:

Observations	Suggestion
Refrigerator does not work properly/does not get cold enough	<ul style="list-style-type: none"> • Check the refrigerator is plugged and switched ON power supply • Check that the refrigerator is placed in such a way that there are proper clearances on the side and top surfaces as mentioned above. • Check if the refrigerator is exposed to direct sunlight or is in close proximity to Gas range / Stove/ OTG or any heat source. • Check whether the temperature setting is at "Winter" condition, if it is then change setting back to "Monsoon / Summer" condition depending on your requirement. • Check the air gaps behind the glass shelves are blocked due to excess storage inside the refrigerator. • Check if the refrigerator loaded with hot food. • Check if the door is kept opened.
Food freezes in the refrigerator compartment	<ul style="list-style-type: none"> • Check whether the temperature settings are in maximum cold temperature condition, if it is then change settings back to mid/low depending on your requirement. • This situation can happen if the ambient temperature near the refrigerator is very less, try to set the refrigerator to higher temperature settings. • Avoid placing moist food or move the food away from the coldest parts of the refrigerator area such as near to duct/vent openings.
Moisture formation outside the refrigerator	<ul style="list-style-type: none"> • Ensure that the refrigerator is not placed directly beneath ceiling fan. • Moisture can be formed during the rainy season or through continuous hot and humid days. Wipe out the surface with a dry cloth.
Moisture formation inside the refrigerator	<ul style="list-style-type: none"> • Make sure that doors are not left open for long time If possible, reduce the frequency of back to back door openings which will increase the chances of moisture entry inside the refrigerator • Avoid placing moist food inside the refrigerator without lid
Refrigerator sounds noisy	<ul style="list-style-type: none"> • Ensure adequate spacing behind refrigerator with the walls of room in which it is placed. • Make sure that the floor is firm and refrigerator is levelled properly on it.
Sounds like water flowing in the refrigerator/freezer section	<ul style="list-style-type: none"> • This sound is due to the Refrigerant R600a gas flow and it happens when compressor starts and stops which is part of normal operation of Refrigerator
Doors do not open easily	<ul style="list-style-type: none"> • Such case happens when you open the door right after closing it. Do not try to force the doors to open; wait for some time before trying again.
Side of the Refrigerator feels warm	<ul style="list-style-type: none"> • Side part of the appliance may feel warm because of the skin condenser provided to prevent moisture formation which is not a product failure.
Bad odor coming from inside the refrigerator	<ul style="list-style-type: none"> • Ensure that foods with strong odor are kept wrapped. • Check if the food placed inside the refrigerator is spoiled/ near to spoil. • Practice regular cleaning inside of the refrigerator to avoid bad odor
Freezing in freezer compartment in Fridge mode	<ul style="list-style-type: none"> • Check whether the refrigerator compartment temperature control setting is set to Low. If not, adjust the setting to Low. • Ensure that the refrigerator compartment door is properly closed without any seal losses and is not kept open unnecessarily for long periods of time.
Freezer knob is hard to rotate	<ul style="list-style-type: none"> • Ensure hands are dry and wipe the knob with a dry cloth. • Turn off the product for 30 min and then rotate the knob.

10. CLEANING & MAINTENANCE

CLEANING

- Cleaning and user maintenance shall not be done by children.
- Before cleaning, unplug the appliance from the power mains – switch off the appliance and unplug the power cord from the wall outlet.
- Remove all the food items stored before cleaning the refrigerator.
- Use a soft cloth to clean all surfaces. Cleaners that contain abrasive substances, acids, or solvents are not suitable for cleaning as they may damage the surface.
- Clean the appliance exterior with water or a mild appliance cleaner.
- Powder Coated and Aluminium surfaces may be cleaned with lukewarm water to which you have added a mild detergent.
- Use of cleaners with low alcohol content is allowed (e.g. window cleaners).
- Do not use cleaners containing alcohol for cleaning plastic materials. Spills of cooking oil, butter, etc. can cause plastic parts to crack.
- Appliance interior can be cleaned with lukewarm water to which you can add some vinegar. To keep the inside of the appliance clean without odor or dirt, regular cleaning is required at least once a month.
- Do not wash the parts of appliance interior equipment in a dishwasher as they may be damaged.
- The water drain system and the opening may be clogged.
- Inspect them often and clean if necessary (e.g. with a plastic straw).
- Do not pour water on the refrigerator/freezer directly.

- After cleaning, switch the appliance back on and insert the food.
- Wipe off the water from the floor, if there is any spillage while cleaning the refrigerator or during the defrost cycle.
- Caution needs to be taken during cleaning to prevent the entry of water into the electrical components such as light bulb, switch etc. Usage of acids, solvents or abrasive powders needs to be strictly avoided as it can tarnish the refrigerator surfaces.
- Ensure that the gasket is rightly placed and the door properly closed to prevent the entry of cockroaches & other insects that can be harmful to your stored food items.

Precautions to be followed while handling the refrigerator:

- Use door handles to open and close the refrigerator, it is not recommended to open the door holding door sides or accessible gaps provided on the use, you can hurt your hand while following malpractices.
- Do not use excessive pressure on door handles, or hang any load on doors like shopping bags etc, there is danger of refrigerator door misalignment or unbalanced product might fall off.
- Foods should not protrude from the shelves. They can fall and hurt your feet or not close the door properly affecting the performance of the refrigerator.
- Prevent overloading the door bin, as there is risk of bottles tilting off if they are not properly kept.
- Do not reach out your hands or legs under the Refrigerator (when cleaning under the refrigerator), You can be hurt by rough edges and parts under the refrigerator.

ACCESSORIES HANDLING & CARE

TOUGHENED GLASS SHELVES

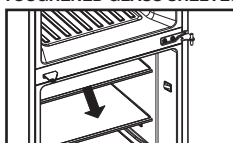

Gently hold the shelf provided in Freezer/Refrigerator compartment from the front side properly. Tilt it slightly from the front side to down and take out the shelf slowly.

VEGETABLE CRISPER

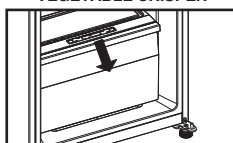

Gently hold the Vegetable crisper provision at the top of front wall. Now pull the vegetable crisper forward to fill vegetables or take out completely based on your requirement.

DOOR BINS

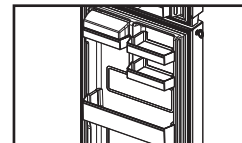

Gently hold the Door Bins provided in Refrigerator and freezer compartment from the side walls. Now lift the Door bin towards upward direction until it is out of its holding area.



11. HELPFUL HINTS

Suggestion for storing foods

- Always clean fruits and vegetables prior to refrigeration. They should be washed and wiped dry before storing.
- Packed foods should be wiped clean before storing as to avoid adjacent foods from spoiling.
- Do not refreeze food items once they have been thawed. This can cause loss of taste and nutrition.

In case of power failure

- Do not open and shut the door as long as you can. There is no problem storing the food inside for about 2-3 hours even in midsummer.
- In case of predicted power failure, do not store any more food and make as much ice as you can to put it on the upper shelf of the fresh food compartment. The inside would be kept cold.

When not using for a long time

- Clean the inside and leave the doors open for 2-3 days in order to prevent mold development or odor saturation.
- Your device is equipped with a maintenance free LED light. Any repair work on the lighting must only be carried out by a qualified electrician.
- Allow hot food to cool before storing in the refrigerator as it can spoil other food items and lead to higher energy consumption.
- Do not open the door frequently / Do not keep the door open for a long time as it can cause rise in temperature of the refrigerator/ freezer compartment and also leads to higher energy consumption.

For retaining freshness of vegetables (other than leafy vegetables) for longer durations, it is advisable to store them in food grade poly-bags.

12. DISPOSAL OF OLD APPLIANCE

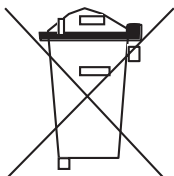

Packaging is made of environmentally friendly materials that can be recycled, disposed of, or destroyed without any hazard to the environment. The symbol on the product or its packaging indicates that the product should not be treated as normal household waste. The product should be taken to an authorized collection centre for waste electric and electronic equipment processing. Correct disposal of the product will help prevent any negative effects on the environment and health of people which could occur in case of incorrect product removal. For detailed information on removal and processing of the product, please contact the relevant municipal body in charge of waste management, your waste disposal service, or the store where you bought the

product. For more detailed information about recycling contact IFB Care. This way, the appliance recycling organized by IFB Care will be done according to E-waste Rules published by the Government of India.

Instructions for removing an obsolete appliance:

- 1) Disconnect the appliance from the power mains.
- 2) Do not damage the refrigerant circuit to prevent pollution.
- 3) C-Pentane is used as an insulation blowing gas. The flammable insulation blowing disposal procedure. Do not try to separate any components from the refrigerator.
- 4) Do not allow children to play with the appliance.

This product is environmentally sound and sustainable free from Pb, Cd, Cr+6, Hg, PBBs and PBDEs Restricted in accordance with the Directive.

13. WARRANTY CARD

IFB REFRIGERATORS, TERMS AND CONDITIONS

For safety and as a standard operating practice, it is important to install the Refrigerator with an MCB provided supply, with proper provision of electrical earthing done. Always ensure that the MCB is in ON condition and not in a bypass condition.

ONE YEAR STANDARD WARRANTY*

IFB Refrigeration Ltd (IFB) (the Company) warrants to the original domestic purchaser of this Refrigerator (appliance) that it is free from defects in workmanship and materials. During 12 months, starting from the date of purchase of the Refrigerator, all the parts of the Refrigerator which prove to be defective as a result of workmanship and/or materials, shall be replaced or repaired free of charge (except for the parts described in this warranty as beyond the scope of the above) on intimation to the Company/Company's authorized service centre nearest to the place where the appliance is installed. Plastic and rubber parts, sheet metal/paint affected by environment led rusting on exposure are not covered under the warranty.

ADDITIONAL WARRANTY PARTS

Compressor after Expiry of Standard Warranty of 1 year, an additional warranty of 9 years will be provided on the compressor. During this additional warranty period, IFB will repair/replace the compressor. This is subject to an inspection by IFB of the compressor and proof that the Refrigerator has been serviced only by IFB's authorized service franchisee. The repair/replacement shall be valid for manufacturing defects only, gas charging and labour costs will be chargeable.

FOUR YEARS SUPER WARRANTY ON PRODUCT*

Super Warranty of 4 years may be purchased by the customer by paying additional amount as Prevalent at the time of installation/purchase (as per the Company's prevalent scheme) or by calling IFB customer care. This will be valid only within 90 days of the product purchased. During this super warranty period, functional parts other than sheet metal and plastic parts shall be covered for replacement/repairs. Any additional expenses or visit charges shall be extra and is not covered under the scope of super warranty. This will be subject to inspection by IFB and proof that the Refrigerator has been serviced only by the authorized service franchise of IFB. Plastic and rubber parts, sheet metal/paint affected by environment led rusting on exposure are not covered under the scope of super warranty.

Super warranty shall be applicable on models as decided by IFB.

Note: IFB shall not honour any warranty/super warranty related claims for the Refrigerator installed and/or serviced/repaired or parts modified by unauthorized service providers.

TERMS AND CONDITIONS

The one-year warranty and additional four years Super Warranty are subject to the following

1. This warranty is not valid in case of the following events:
 - a) The warranty card is not fully filled in and signed at the time of purchase/ Company's authorized franchisee/dealer/service engineer.
 - b) If the completed warranty card is not presented to the authorized personnel at the time of service/repair. Customers may be asked to furnish proof of ownership and date of purchase by showing the sales receipt/purchase invoice. The warranty claims as accepted will be only for the original purchaser.
 - c) The warranty is non-transferable to anyone who subsequently purchases, leases or otherwise obtains the product from the original purchaser. If the appliance is not used in accordance with the manufacturer's instructions given in the user manual.
 - d) If the Refrigerator has been installed, serviced, repaired, opened or tampered with by unauthorized personnel.
 - e) If defects arise/are caused by accidents, alteration, misuse, neglect, abuse, substitution of original components with spurious/non genuine components, use of/application of harmful chemicals on machine, attack by household pest/rodents, fire, flood, earthquake, lightning, and/or any other acts of God/natural calamities.
 - f) If defects arise with optional accessories like stabilizer, covers, extended power cables, external refrigerator stands, control knobs, electrical plugs, other detachable parts etc.
 - g) If damages occur owing to improper electrical circuits outside the Refrigerator or by any external electrical supply thereof. This includes failures due to erratic power supply, fluctuations beyond rated voltage + 10% voltage and frequency of 50 Hz + 3%, AC power supply systems.
- h) If the Refrigerator is run frequently on power back-up or solar power.
 - i) If the Refrigerator serial number on the appliance is defaced, missing or altered.
 - j) If the appliance is taken out of the territory of the Republic of India.
 - k) This warranty will automatically terminate on the expiry of the warranty period of 12 months or extended warranty (optional) as per the scheme, even if the Refrigerator has not been in use for any time during the warranty period or extended warranty period for any reason.
2. This Warranty does not cover normal wear and tear, any type of corrosion, rust, stains, scratches, peeling paint, dents on the body. Also, the company is not liable for any incidental or consequential damages.
3. Parts replaced or repaired under Standard and Extended warranties are warranty throughout the remaining of the original warranty period.
4. The company is not liable for any delay in servicing owing to reasons beyond the control of the company or any of its authorised service centres.
5. The warranty is not applicable if the Refrigerator is used for commercial / semi commercial purposes.
6. For any service under warranty beyond city/town/municipal limits from the Company/authorised service centres, a fixed charge as per the Company's norm will be collected from the customer. In addition to the actual to and from charges by the shortest route. Alternatively, the customer may bring the appliance to the nearest service centre for carrying out the necessary repairs, at customers own cost.
7. The warranty does not cover regular maintenance.

CUSTOMER DETAILS CUM WARRANTY CARD

Mobile No. _____ Customer copy (to be retained by customer)

Product Serial No. _____ Date of Purchase _____

Name _____

Address in Full _____

Telephone No. _____ Model No. _____

Dealer Name & Address _____

Customer's Signature & Date

(I accept the Terms & Conditions of warranty)



RF221PRUSM005

Dealer's Signature with rubber Stamp



For any assistance, reach us at **IFB CARE** 080 695 45678 | 080 458 45678 or WhatsApp ☎ 91 9231004321